

MIMAP Project Philippines

Micro Impacts of
Macroeconomic Adjustment
Policies Project

MIMAP Research Paper No. 1

Micro Impacts of Macroeconomic Adjustment Policies (MIMAP): A Framework Paper and Review of Literature*

*Mario B. Lamberte, Gilberto M. Llanto, Aniceto C. Orbeta Jr. and Ma.
Lucila Lapar*

February 1991

Paper Presented During the Workshop with the same title held on February 11-12,
1991 in Los Banos, Laguna, Philippines.

This work was carried out with the aid of a grant from the International Development
Research Centre, Ottawa, Canada.

MIMAP Project. Policy and Development Foundation Inc.

Unit 7B Vernida I Condominium, 120 Amorsolo Street, Legaspi Village, Makati 1229, Metro
Manila, Philippines

Telephone: (632) 813-6178 to 79, 816-3263 Fax: (632) 813-6179 E-mail: mimap@pacific.net.ph

*Also Published as PIDS Working Paper Series No. 91-02.

MICRO IMPACTS OF MACROECONOMIC ADJUSTMENT POLICIES (MIMAP): A FRAMEWORK PAPER AND REVIEW OF LITERATURE*

*Mario B. Lamberte, Gilberto M. Llanto,
Ma. Lucila Lapar and Aniceto C. Orbeta, Jr.***

WORKING PAPER SERIES NO. 91-02

I. INTRODUCTION

There has never been a decade when the Philippine economy did not experience a crisis. By this time, Filipinos should have already been accustomed to crises, that any crisis in sight should not be cause for any concern. However, the nature and gravity of economic crises have changed lately and this merits more serious attention, as shown in Figure 1. In the 1970s, economic growth fluctuated within a narrow band, but growth was generally positive and relatively high by LDCs¹ standard. In the 1980s, however, economic growth fluctuated widely and became negative for two consecutive years. What worsened the situation was that growth appeared to have decelerated fast in the last two years, with a great possibility of going down further if no measures would be taken to reverse the trend.

Figure 2 provides the implication of the changing character of the economic growth over the last two decades. Real per capita income continued to rise in the 1970s despite fluctuation in economic growth, but it plunged precipitously in the 1980s. The highest per capita income achieved in 1981 has never been recouped up to now, and it seems that it will not be reached in the next few years, considering the magnitude of the economic problem at hand.

Figure 3 gives another implication. The under-employment rate increased in the 1980s. Although it declined in the second half of the 1980s, it had remained relatively high compared to the second half of the 1970s.

What is the implication of all these household welfare? This is indeed difficult to answer since there is no single quantitative indicator that can satisfactorily measure household welfare. Certainly, health status is one of the indicators of household welfare, and infant mortality rate

* This study was made possible through the financial assistance of the International Development Research Centre (IDRC). Special thanks go to Dr. Randy Spence and Mr. Christopher W. MacCormac of IDRC for encouraging the conduct of this study. Likewise, this study has benefitted from the comments of the participants of the workshop with the same title held on 11-12 February 1991 at the City of Springs, Los Baños, Laguna.

** Vice-President (Philippine Institute for Development Studies), Executive Director (Agricultural Credit Policy Council), Research Associate (Philippine Institute for Development Studies) and Director (Agricultural Credit Policy Council).

¹ LDCs – less developing countries.

Figure 1
GNP GROWTH RATE

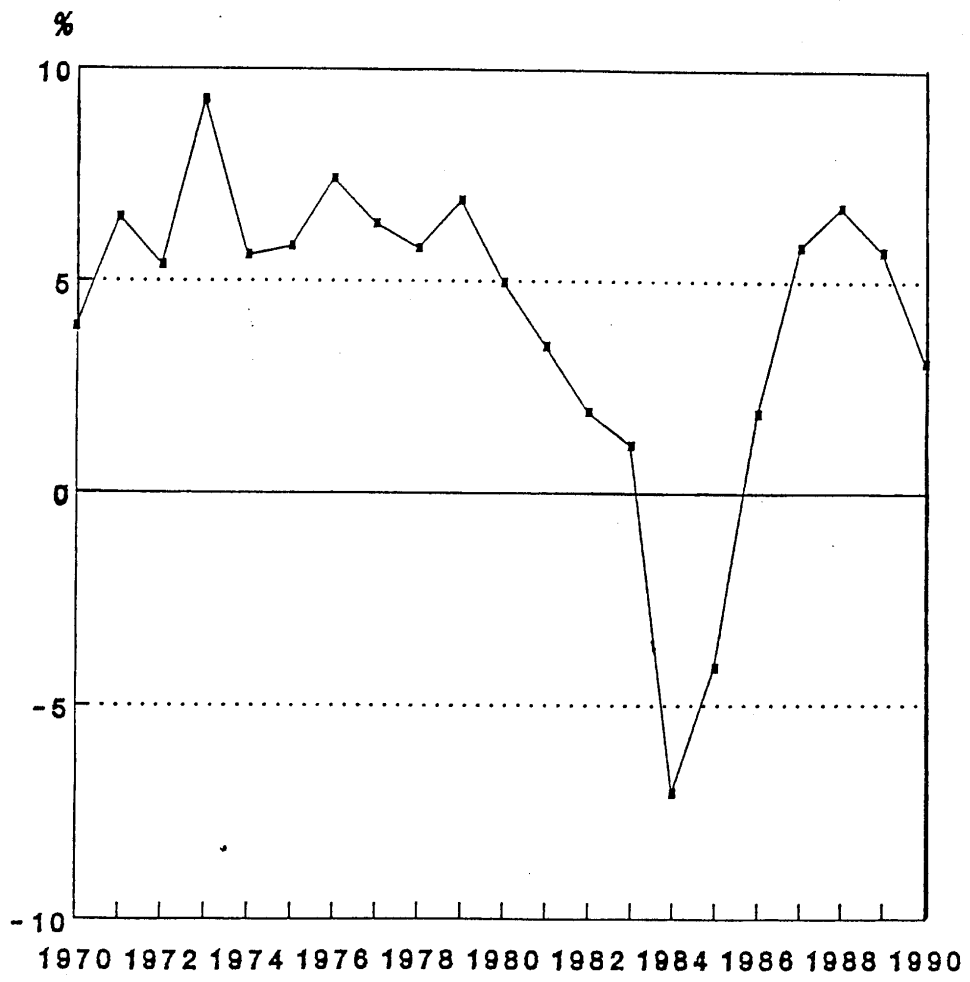

Figure 2

REAL PER CAPITA INCOME

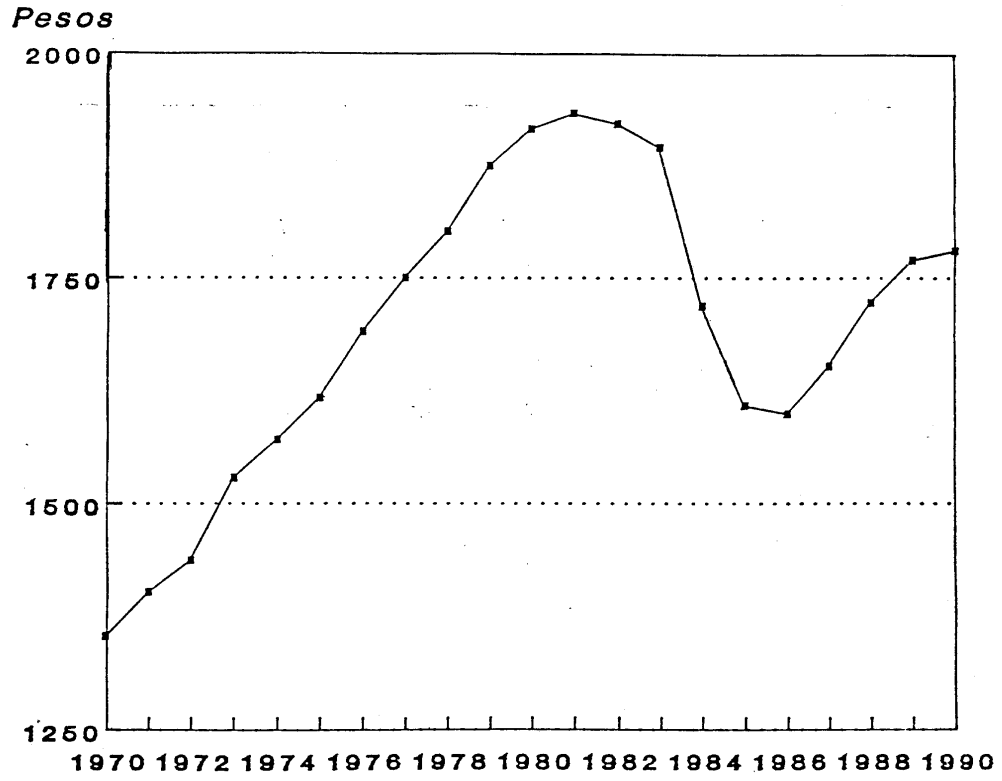
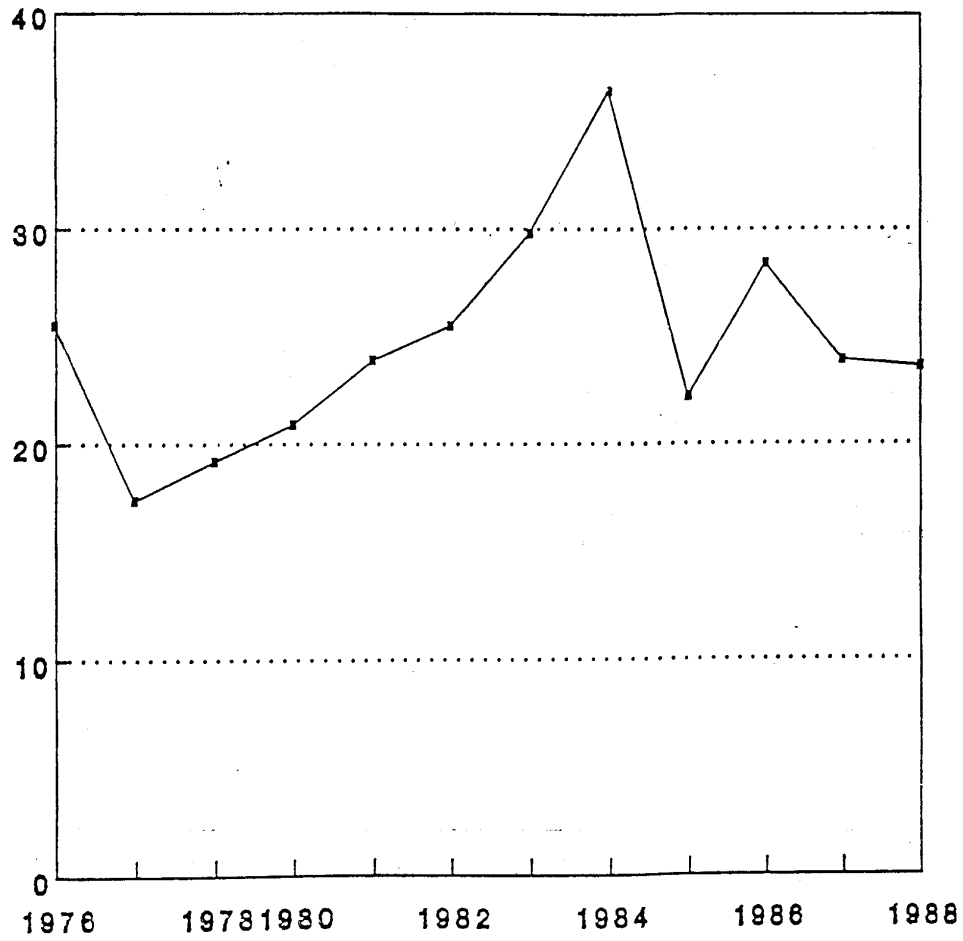

Figure 3

UNDEREMPLOYMENT RATE



could be used as a rough indicator of health status because infants are most sensitive to changes in health conditions.

Infant mortality rate has been generally declining over the past two decades. This could be due to a host of factors, one of which is improvement in technology of child care. However, this rate of decline slowed down in the 1980s, as shown in Figure 4. Also, the rate of decline in infant mortality rate appears to be strongly correlated with the underemployment rate. Specifically, the rate of decline in infant mortality rate accelerated during periods of lower underemployment rates, and decelerated during the periods of higher underemployment rates. This strongly suggests that macroeconomic policies have a direct bearing on household welfare; and this implies that one should examine closely the impact of macroeconomic adjustment policies at the micro level. Unfortunately, this aspect has been given little attention in fashioning adjustment programs.

This paper attempts to lay the groundwork for more vigorous studies on the micro impact of macroeconomic adjustment policies in the Philippines. The specific objectives are:

1. To provide a framework for analyzing the impact of macroeconomic adjustment policies at the micro level, i.e., household level;
2. To describe and analyze the current state of macroeconomic policies and their impact on the economy.
3. To review sectoral studies that may provide insights into the factors that may lay important roles in understanding the impact of macroeconomic adjustment policies on households;
4. To assess the availability of data needed to monitor the impact of macroeconomic policy at the household level; and
5. To suggest areas for future research.

II. THE CONCEPT OF ADJUSTMENT POLICIES²

Before we proceed, it is important to discuss the concept of adjustment policies used in this paper. Adjustment policies describe all policies designed to address serious imbalances faced by a country. These imbalances between aggregate demand and supply are manifested in persistent balance of payment deficit, high inflation rate, and unsustainable fiscal deficits. They encompass both stabilization and structural adjustment policies.

Stabilization policies are aimed at correcting imbalances in the external accounts within the short run by reducing expenditures, taking the structural parameters of the economy as given. In general, stabilization policies tend to be deflationary. Structural adjustment policies, on the

² This part draws on Cornia et al. (1987) and Montes (1986-1988).

other hand, aim to change the structural parameters of the economy so as to simultaneously reduce imbalances and accelerate economic growth over the medium term. A key element here is sufficiency and efficiency of investment to support a sustainable economic growth. Montes (1988) pointed out that “a successful stabilization program is not necessarily consistent with structural adjustment.” For instance, a severe cut on government infrastructure expenditure would quickly stabilize the economy but it could undermine structural adjustment.

Macroeconomic adjustment policies may be classified into five major groups: monetary, fiscal, exchange rate, foreign trade, and price and wage. Under an adjustment program, monetary policy is generally made tight while savings are being encouraged. Fiscal policies are aimed at reducing budget deficit through any of three means: (1) drastic cut in public expenditures without additional revenue-raising measures, (2) introducing new revenue-raising measures while maintaining expenditures constant, or (3) modest cut in government expenditures coupled with additional revenue-raising measures. Options 1 and 3 could involve reduction in or phasing out of subsidies. Exchange rate policy under an adjustment program demands a devaluation to correct the overvaluation of the domestic currency. Trade policies could involve changes in export taxes and import duties. Finally, price policy would favor deregulation while wage increases are being restrained.

Although the immediate objective of adjustment policies is to alter the values of certain macroeconomic aggregates, they ultimately affect the households. For instance, the abolition of food subsidies may be a key factor in correcting the budget deficit, but it would adversely affect the health and nutrition of household members who used to enjoy these subsidies. Our interest in this paper lies in determining the little known impact of these adjustment policies on household welfare.

III. ANALYTICAL FRAMEWORK

This section provides a framework for analyzing the impact of macroeconomic adjustment policies on household welfare. Of particular interest is the effect of adjustment policies on the poor or vulnerable groups. Adjustment policies may adversely affect the poor in two ways (Demery and Addison, 1987): (1) in the short run, such policies may reduce real income and consumption of poverty groups; and (2) over the long term, poverty groups may not benefit from the changes brought about by the adjustment policies. Although adjustment policies are necessary for sustainable growth in the long term, there is some fairly good amount of evidence that unwarranted impacts may arise. Cornia, Jolly and Stewart (1987) pointed to the predominantly deflationary nature of adjustment policies that lead to an increased incidence of poverty through depressed employment and real incomes and, secondly, the direct negative effects of certain macro policies on the welfare of certain socioeconomic groups.

The phenomena to be studied are “complex and are embodied in a complicated, dynamically-evolving context” (Behrman 1988). There is also the difficulty of segregating the effects of adjustment policies per se from those that would have been caused by preadjustment trends and macroeconomic imbalances (Thorbecke 1988). We propose to put together a series of building blocks to capture the complex process involved in tracing the interactions between

Figure 4

PERCENT CHANGE OF INFANT MORTALITY RATE
(PER 1000 LIVE BIRTHS)

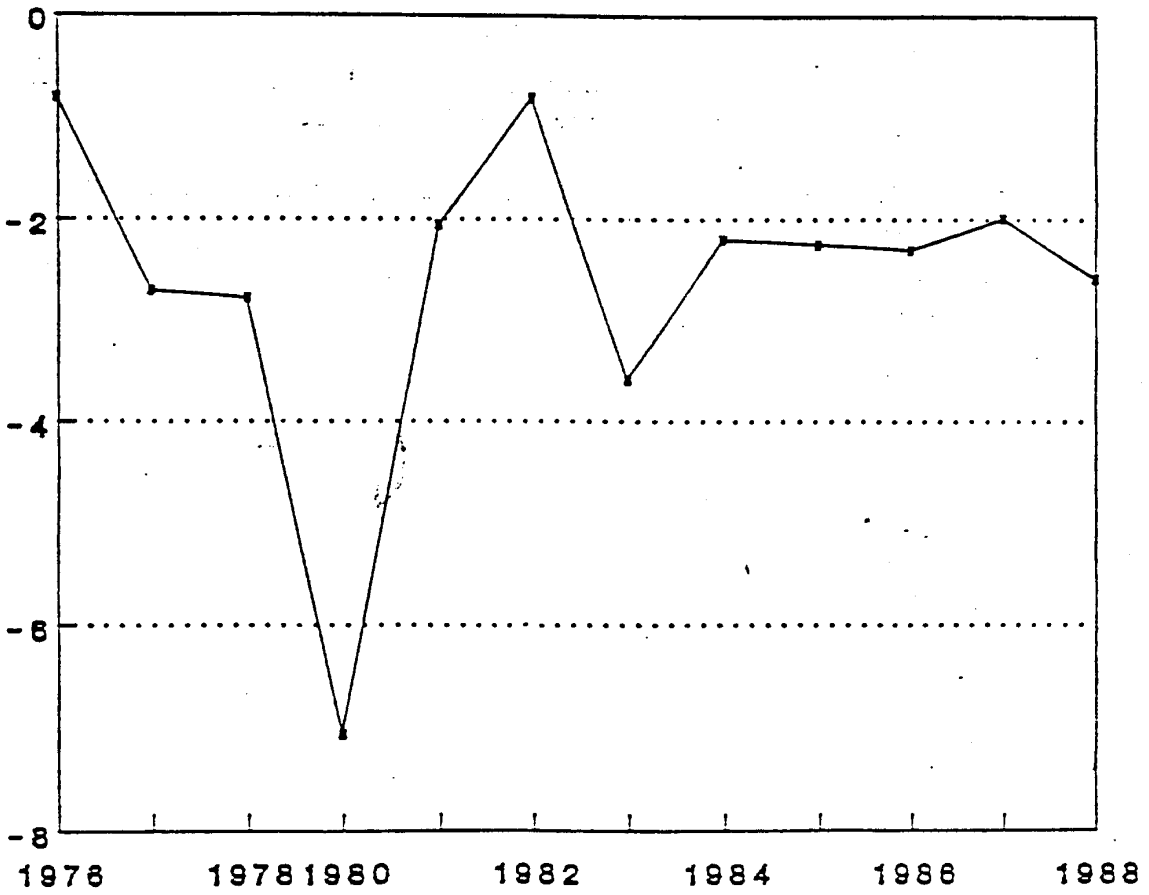

macro adjustment policies and the ultimate object of any economic policy, i.e., the wellbeing of households.

When we discuss the macroeconomic policies of a small, open economy, we are usually interested in a relationship as depicted in Figure 5, where the object of interest is determining national income and employment. Our concern in the macro side of things is to understand the behavior and performance of the economy as a whole and, through various macro policies, to be able to influence the so-called macro aggregates such as level of output, employment, inflation and the balance of payments. In a small open economy, the world environment determines to a certain extent the shape of national economic policy; it also directly affects the domestic economy.

A. Micro Level: Households

There is a conventional distinction between this macro world and the micro world of the household. Figure 6 presents the household whose well being (defined in terms of its health and nutrition, level of education, and similar attributes) depends upon the value of the household's real purchasing power. The households are assumed to be homogeneous, that is, they are all participants in the formal market economy. The household's purchasing power depends on (1) its initial endowment of wealth (assets), (2) its wage income through the labor market, (3) public provision of goods and services, and (4) the inflation rate. This is the standard optimization framework in which the household chooses the bundle of goods and services that gives it the greatest level of welfare, subject to a budget constraint. The household's productivity, which is partly conditioned by its health and nutrition status, level of skills and education etc., in turn, defines its performance in the labor market. With better skills and health, the household commands relatively higher wages and enjoys a bigger (and better) consumption bundle.

Included in the goods and services market are the production units. These units may be the more organized manufacturing establishments or the micro and small-scale production units, usually organized and operated at the household level e.g., micro and cottage enterprises.

An important sub-sector of the goods and services market is the financial market. Production units' access to financial resources and services is a key factor in generating outputs and income. McKinnon (1973) pointed out that lack of access to financial resources may confine production units to traditional, less productive technology.

The next step is shown in Figure 7 where we try to link the macro economy with the micro world of the households. This highlights the mechanisms through which macro policies influence the wellbeing of the household. There are three dominant channels of influence: (1) the factor market where the household makes decisions regarding time, consumption, investment, and location of employment; (2) the goods and services market where the household expresses preferences for goods and services given their prices; and (3) the impact of the absence or presence of particular public/social goods such as potable water, preventive health care, housing and sewage, and various subsidies that directly affect the household.

Figure 5

MACRO ANALYSIS

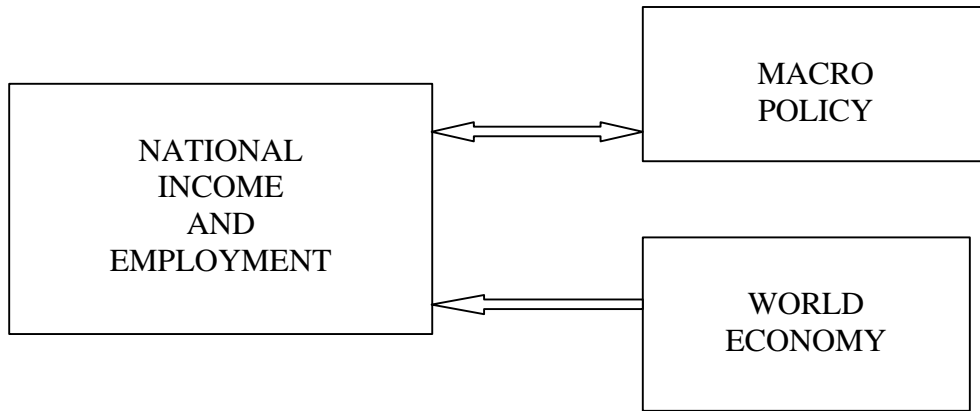

Figure 6

MICRO ANALYSIS

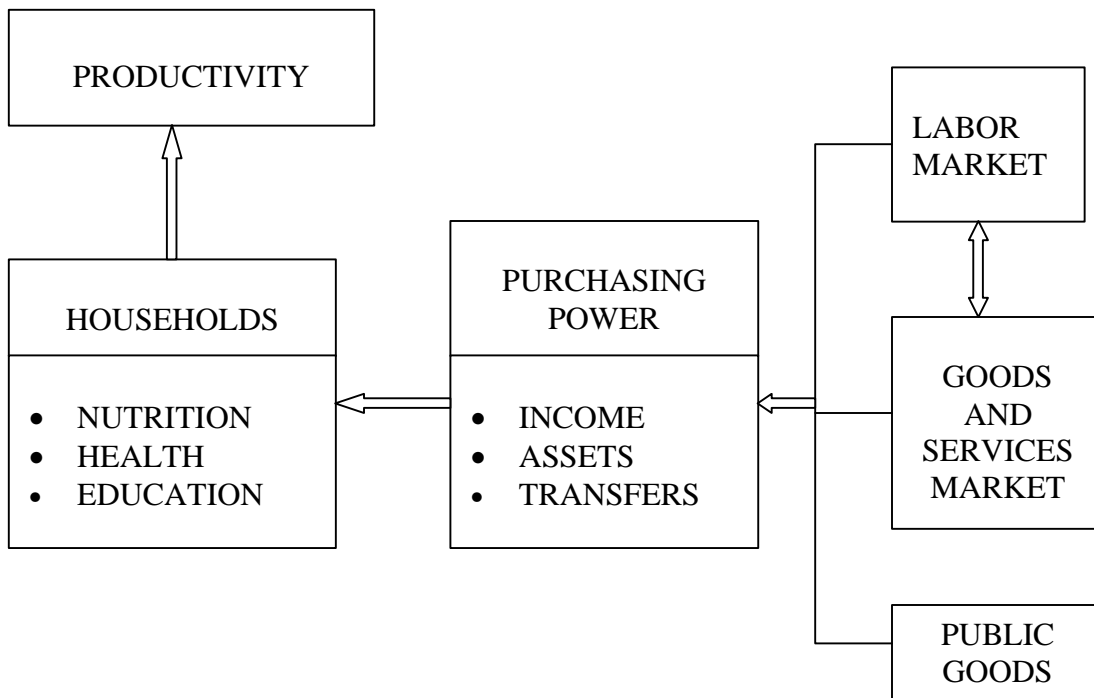
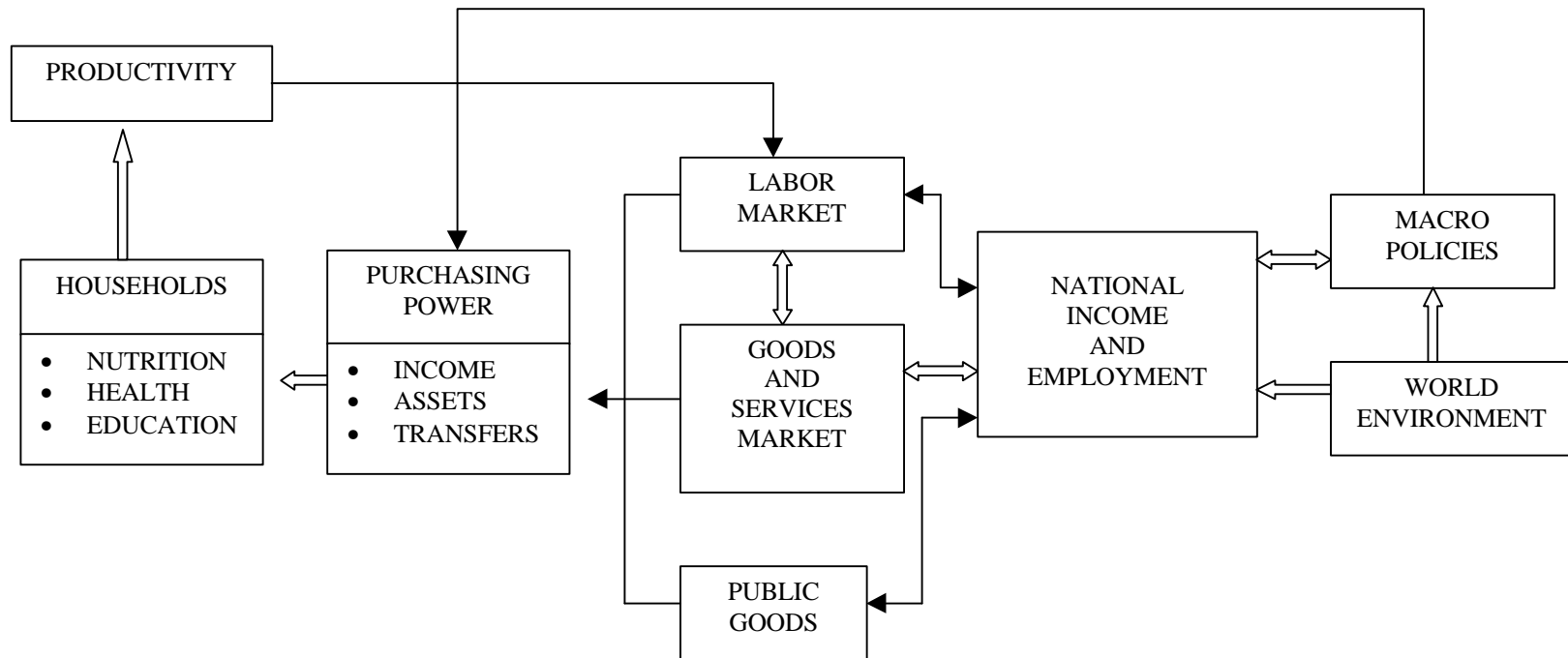

Figure 7

**MICRO IMPACT OF MACROECONOMIC POLICIES:
HOMOGENEOUS HOUSEHOLDS**



Household employment and wages determine to a great extent effective demands for food, health, nutrition, clothing, housing, and education. A decline in employment or a cut in real wages brought about by adjustment policies like expenditure-reducing policies will reduce the effective demands for these items. Likewise, macro policies not only alter incomes and earning opportunities but also consumer prices paid by households. Actual consumption of items that determine household wellbeing such as food, adequate clothing, and shelter depends on relative price differentials and real income. Adjustment policies could alter relative price differentials, which would elicit a corresponding response from the households.

The availability of public and social goods directly affects household welfare. Budget cuts as well as other expenditure-reducing policies, to the extent that these are directed to expenditures for public and social goods, will have an adverse impact on household welfare.

B. Physical Environment and Natural Resource Dimensions

A further progression in our framework is seen in Figure 8 where the country's institutional dimensions and the physical environment/natural resource base are brought into the picture. Economic agents do not exist in a void. The exchange economy operates within a complex social and institutional framework that conditions the interaction among economic agents. North (1989) defines institutions as rules, enforcement characteristics of rules, and norms of behavior that structure repeated human interactions. They define and limit the choice set of economic agents. For example, the recognition and establishment of property rights and the organization (or agency) created to enforce them "allow individuals in highly complex interdependent situations to be able to have confidence in their dealings with individuals in highly complex interdependent situations to be able to have confidence in their dealings with individuals of whom they have no personal knowledge with whom they have no reciprocal and ongoing exchange relationship" (North 1989).

The wide and complex set of interdependent relationships in a complex exchange economy gives rise to opportunistic behavior and high transaction costs. Over time, societies have developed various institutional structures (formal contracts and guarantees, property rights, vertical integration, limited liability) to reduce the uncertainty of impersonal exchange and prevent huge transaction costs (Bardhan 1989). In our framework, the efficient performance of the labor and goods market and the efficient delivery of public goods and services are influenced by established or emerging social conventions and societal norms that are enforced or implemented by agencies or organizations (government or private). To this, we add the kind of market structure that may be promoted by certain policies. For instance, licensing regulations are so stiff that only a few are allowed to operate in a certain industry; thereby giving rise to oligopolistic behavior. Very high minimum capital requirements, for example in banking industry, may also produce similar results.

Likewise, the state of technology represents an important dimension affecting the efficiency of the labor market and the goods/services market. To the extent that production processes are hampered by primitive technology or the lack of appropriate technology, households will be adversely affected because of a stagnant labor market and goods/services

Figure 8
MICRO IMPACT OF MACROECONOMIC POLICIES:
HOMOGENEOUS HOUSEHOLDS WITH INSTITUTIONAL DIMENSION

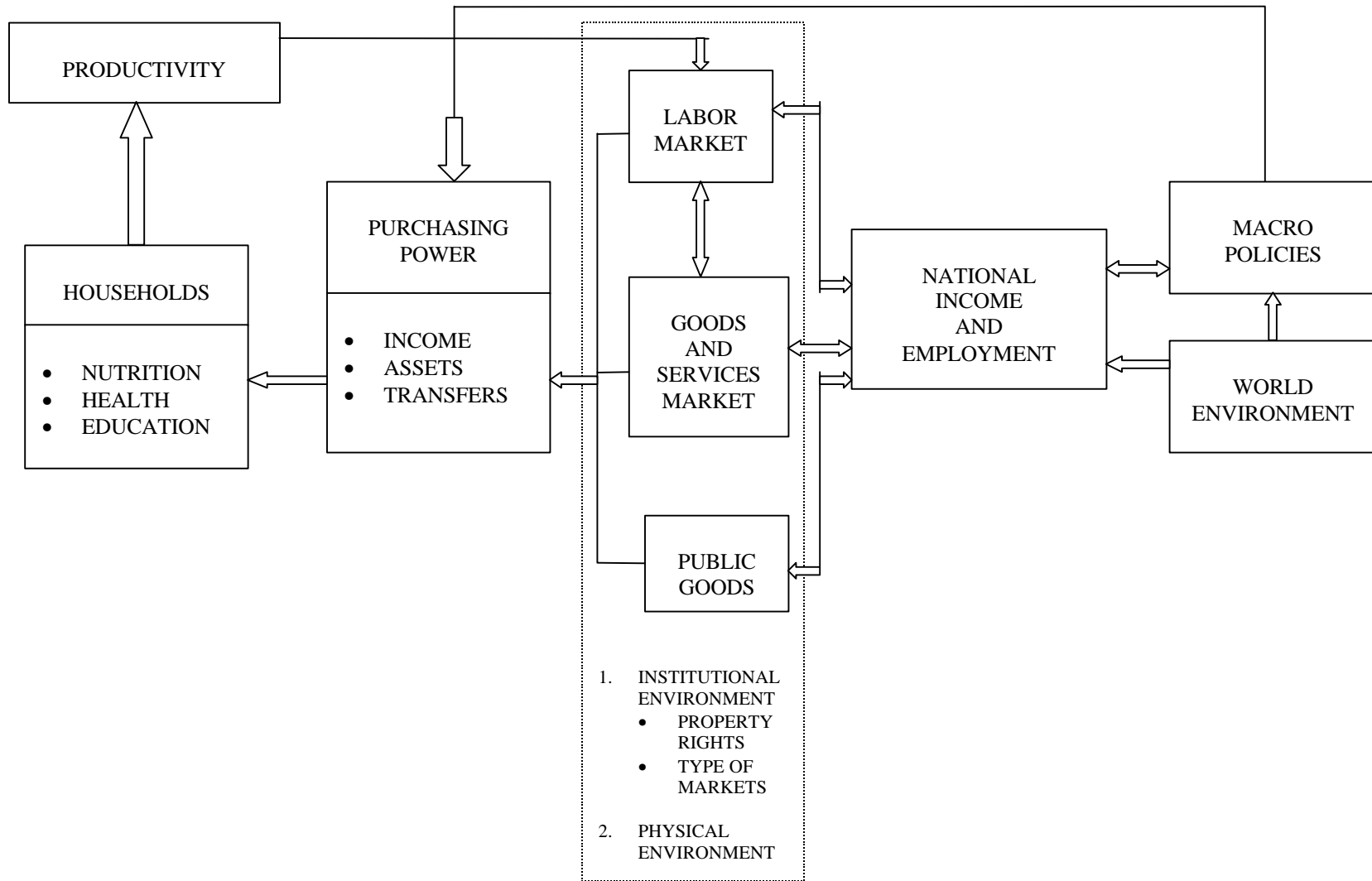

market. If macro policies help bring about access to modern technology, the households will have better prospects in a growing labor market and goods/services market.

On the other hand, the physical environment and the natural resource base provide the setting that conditions, to a certain extent, the country's ability to generate economic growth, create jobs, and alleviate poverty in a sustainable manner. The physical environment and the resource base interact with macro policies to further define the ability of households to transact in the labor market and goods and services market. For example, trade and industrial policy reforms may bring about economic growth but, at the same time, harm the environment and rapidly deplete non-renewable resources. Likewise, agricultural production systems that severely violate the environment may be promoted by policies. Marginalizing the environment will bring about more difficulties for households, and as people intensify their exploitation of the country's natural resources, further degradation of the environment and natural resource base results.

C. Influence of Political Groups

There is a big difference between Figures 7 and 8 in terms of sharp divergences in performance across similarly situated LDCs pursuing similar adjustment programs. Whenever institutions are weak or non-existent, the adjustment program is likely to fail. In such a case, fashioning a genuine adjustment program should include institutional reforms, along with changes in economic policy. In the same manner, an adjustment program that does not consider the operating institutions will have less probability of success. In the political arena, for instance, Waterbury (1989) identified different political groupings and the kind of actions they would support that would undermine the adjustment process (Table 1). By the same token, an adjustment program that does not address the issues of sustainable development of the resource is likely to bring about perverse results.

D. Monetized *vis-à-vis* Subsistence Households

Our final framework is shown in Figure 9 where we further distinguish between monetized households and subsistence households. Those in the monetized sector participate in market activities while the subsistence households engage in their own production and consumption and rarely, if ever, interact with the market. The monetized households are further divided into (1) those engaged in formal activities in the factor and goods market; and (2) those who, although monetized, comprise mostly the parallel or underground economy.

A subset of the monetized sector are those households who constitute the so-called parallel or underground economy. They are monetized and participate in the market, but most of their participation is informal or "invisible" as when they engage in such informal and non-registered activities as food vending, hawking, retail trade, and personal and repair services. It is important to consider this subsector because in many developing countries the informal sector is a large sector; according to de Soto (1989), majority of the people in many developing countries comprise this sector. It is also important to study this sector because it may be society's safety valve in periods of stress because of its capacity to absorb those eased out of the formal monetized sector by a changing environment. From another vantage point, the informal sector may be the training ground for active and visible participation in the market economy.

Table 1
 TYPOLOGY OF POLITICAL GROUPS AND
 ACTIONS TO UNDERMINE ADJUSTMENT PROCESS

Political Groups	Disruptive Activities
Organized labor	Strikes
Unorganized urban and low-income groups	Riots
Private sector importers	Capital Flight
Migrant and skilled labor	Remittance withholding from abroad
Public Sector enterprises	Hoarding and unsecured borrowing
Politicians ^{1/}	Refusing to pass the required legal measures

^{1/}Added to Waterbury's classification.

Source: John Waterbury, "The Political Management of Economic Adjustment and Reform," in Joan M. Nelson *et al.*, *Fragile Coalitions: The Politics of Economic Adjustment* (New Brunswick, New Jersey: Transaction Books, 1985).

Figure 9
MICRO IMPACT OF MACROECONOMIC POLICIES:
HETEROGENEOUS HOUSEHOLDS WITH INSTITUTIONAL DIMENSION

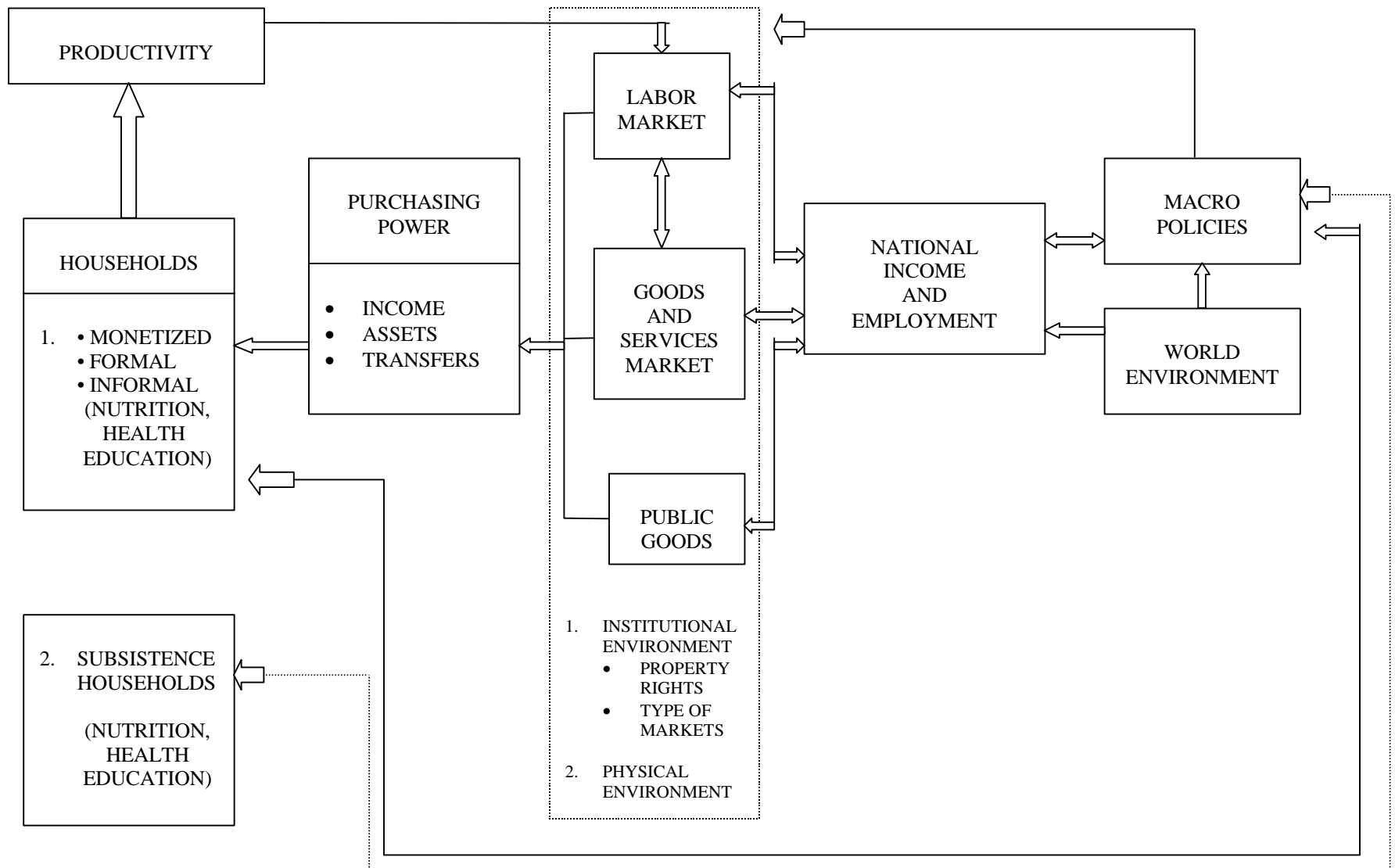

An interesting issue is the incidence of public goods and services among households. While the government may have the best interest of the low-income groups in its delivery of public goods and services, the actual incidence may be something else. Households (heterogeneous as they are: monetized vs. subsistence, formal vs. informal, high vs. medium vs. low income, etc.) have different abilities to influence the distribution mechanisms of such public goods and services. As Nabli and Nugent (1989) put it, the state and its agents are not neutral and indifferent to this activity and, thus, their role should also be considered.³

E. Overall Analytical Framework

To recapitulate, our framework as outlined in Figure 9 looks at the interaction between macroeconomic policies and heterogeneous households, given a country's particular institutional structure and natural resource endowments. The transmission mechanisms are (1) the labor market, (2) the goods market, and (3) the delivery of public goods. A distinguishing feature of this framework suggests that macroeconomic adjustment policies have differential impacts on different groups of households. For instance, a cut in government expenditures to reduce budget deficits could mean layoffs to some government workers and slowdown in implementing major public infrastructure projects. Private contractors also start laying off workers. Thus, the immediate result is a drop in both government and private sector employment. Households of those who are laid off will experience a drop in their income and, consequently, their purchasing power.

The secondary effect of this on the economy will depend on the strategies to be adopted by those adversely affected in order to cope with the situation. The various coping mechanisms are discussed below. But assume, for the moment, that the adjustment they make is in terms of reduction in real demand for goods and services. Producers of those products and services experiencing a decline in demand will respond accordingly by laying off workers. They may belong to the formal and informal sectors of the economy. Households of these workers will also adjust in the same manner as those households whose members were directly affected by the cut in government expenditures. In Figure 9, all these households belong to the monetized sector of the economy. The subsistence sector by definition will not be affected at all by the cut in government expenditures which resulted in layoffs. However, they will be adversely affected by the absence of government services that they freely avail of.

We can go further with our analysis by working out the transmission mechanisms. A reduced budget deficit would free more resources to the private sector. Together with reduced inflationary expectations, this will bring down real interest rates. Since wage restraint is being in force, this development would encourage more investments, which means that others who were laid off could be absorbed with the expansion in investment. The informal monetized households could benefit from this if there is a strong complementarity between the formal and informal credit markets. However, this would bias the income distribution toward the better-off. This clearly brings out the income distribution effects of adjustment policies.

³ Iqbal (1989) provides a theory of access to subsidies which hypothesizes that the eventual distribution of the subsidized good based on a non-price mechanism is sub-optimal.

The discussion above does not argue against carrying out an adjustment program. Rather, it merely points out that the manner by which adjustment policies are designed and implemented could aggravate the plight of vulnerable groups are considered, perhaps a better adjustment program could be designed to reduce such impact. For instance, compensatory resources could be directly allocated to those who are most likely to be adversely affected by macroeconomic adjustments in order to enable them to cope with a changing environment and, more importantly, to be able to take advantage of the opportunities created by macroeconomic policies designed to restore the growth path.

In conclusion, macroeconomic policy has both a direct and indirect impact on the welfare of households. Thus, an adjustment program should include micro indicators as performance criteria in addition to the usual micro aggregates. This also suggest that an adjustment program, because it intends to position the economy into a growth path, is a process in time and a longer time frame must be accorded it. As the adjustment process unfolds, there must be a conscious effort to monitor impacts at the household level in order to make necessary policy “corrections”, finetuning, and interventions.

IV. RECENT ADJUSTMENT PROGRAM AND RESULTS

This section describes the recent adjustment program initiated by the Philippines and analyzes its results; it also discusses the past, externally financed adjustment programs.

The 1987-1992 Adjustment Program, which the Philippine government committed itself to undertake to obtain three-year extended arrangement with the IMF, draws upon the *Medium-Term Philippine Development Plan, 1987-1992*. Thus, “the basic assumptions remain with the Program, the broad objectives of growth, poverty alleviation, price stability and sustainable external payments position continue to provide the lifeblood of Program, the specific measures in the fiscal, monetary and external sectors are essential replications of the Plan’s” (*CB Review* 1989, p.1). These broad objectives were translated into quantitative economic indicators (Table 2).

Criticisms were raised against the quantitative targets of the Program. One described it as too optimistic, such as the high export target. Another pointed out internal inconsistency, such as high economic growth and greatly reduced government expenditures. While we do not deny the validity of these criticisms, we believe that the success of the Program depends, to a large extent, on the external environment and the actual policy actions undertaken by the government. The actual policy actions made by the government will thus be analyzed in relation to the Program.

A. External Debt Management Policy

The Aquino government inherited a heavy external debt from the Marcos government, posing a major threat to the country’s effort to veer the economy toward a stable and sustainable growth. To counteract the negative effect of this burden, the government opted to pursue a

Table 2
Philippines: Objectives of the Adjustment Program, 1987-1992

	1987 Actual	1988 Prel. Actual	1989	1990	1991	1992
Annual Percentage Changes						
Output and prices						
Real GNP	5.7	6.7	5.6	3.0	6.5	6.5
Consumer prices period average	3.8	8.8	8	14	9.5	7
Money and credit (annual average)						
Broad money	14	20	16.5	15	13-14	13-14
Monetary base	15	11	13	14	11-12	11-12
(As Percent of GNP)						
Public finance						
Public investment	3.6	3.4	3.9	4.7	5.6	5.8
National government deficit	2.9	3.1	2.0	3.6	1.8	0.4
Public sector borrowing requirement ^{1/}	2.1	2.4	2.1	1.6	1.8	2.0
Consolidated public sector deficit ^{2/}	2.7	3.4	4.1	5.2	3.7	2.5
External debt						
Current account deficit	1.3	1.0	2.2	5.7	4.5	3.5
External debt	83.4	72.2	66.7	61.2	56.3	52.1
Debt service (in percent of exports of goods and services) ^{3/}	35.4	33.7	26.5	28.16	24.52	29.4

^{1/}National government deficit plus deficit of monitored corporations less national government transfers to the monitored corporations.

^{2/}Combined deficit of the national government and public financial and monitored nonfinancial corporations

^{3/}After rescheduling.

Source: Memorandum of Economic Policy submitted by the Philippine Government to the IMF, March 1989.

growth-oriented debt management strategy based on the Brady Plan. This consists of continued adjustment, loan rescheduling, the pledging of some official resources through the World Bank/IMF to secure debt and debt service reduction in exchange for certain enhancements on the remaining bank claims, and new commercial lending. This strategy resulted in the following: (1) the debt stock slightly declined over the last four years (Figure 10), and (2) the debt service burden eased up considerably in the same period (see Figure 11). However, this type of strategy provided very little help in minimizing the outflow of much-needed resources from the economy. As may be gleaned from Table 3, net resource transfers have been negative and large, and this situation is expected to continue in the next few years. Any economic growth that would be obtained in the initial years of the program will likely be difficult to sustain. And in such circumstance, it will be politically difficult to continue this external debt strategy. As Ranis (1989, p.14) pointed out, "A structural adjustment program worthy of the name must do more than buy time; it must have a realistic shot at seeing the debtor country reenter in the international capital market and realize the return flow of flight capital."

B. Exchange Rate Policy

In principle, the government expressed support for a flexible exchange rate. But in practice, the Central Bank has been managing the movements of the exchange rate, allowing only small changes in the official rate over time. For the period 1986-1989, the peso depreciated by only 6.6 percent against the US dollar while the effective exchange rate depreciated by 16.7 percent from 1986 to 1988, due mainly to the changes in the currencies of the country's major trading partners. Thus, the peso hardly moved in 1989 despite the rapid build-up of the country's trade and current account deficits in that year. When the peso came under heavy pressure in the foreign exchange market in the mid-1990 because of the deteriorating external environment and the uncertainties arising from the Middle East war, the Central Bank tried to stabilize the peso through exchange market intervention; it also introduced a series of administrative measures such as tight band imposed on the official exchange rate for commercial foreign exchange transactions and a special arrangement that would ensure the supply of foreign exchange oil importers. The recent depreciation of the peso to P28/US\$1 came too little and too late, considering the size of the current account deficit and the more than 10 percent differential between the official and black market rates that still persists. There are indications that a high interest rate was pursued by the Central Bank to defend the exchange rate. But with nominal and real interest rates already high, further increases in interest rates could further slow down domestic investment and hinder economic growth.

C. Fiscal Policy

As a strategy to manage the fiscal deficit to increase investment, the fiscal policy of the Aquino administration focused on measures designed to raise revenues and optimize the use of scarce budgetary resources (Diokno 1990). These measures include adjustment in the tax structure (the 1986 tax reform program and tax administration) and improvement in the quality and distribution of government expenditures, such as allocating more resources to the services sector. Despite efforts to trim government expenditures, the budget deficit continued to rise both in nominal terms and relative to GNP. As a percent of GNP, the consolidated public sector deficit rose from 2.2 percent in 1987 to five percent in 1990. Several factors account for this:

Figure 10

EXTERNAL DEBT STOCK

1980-1989

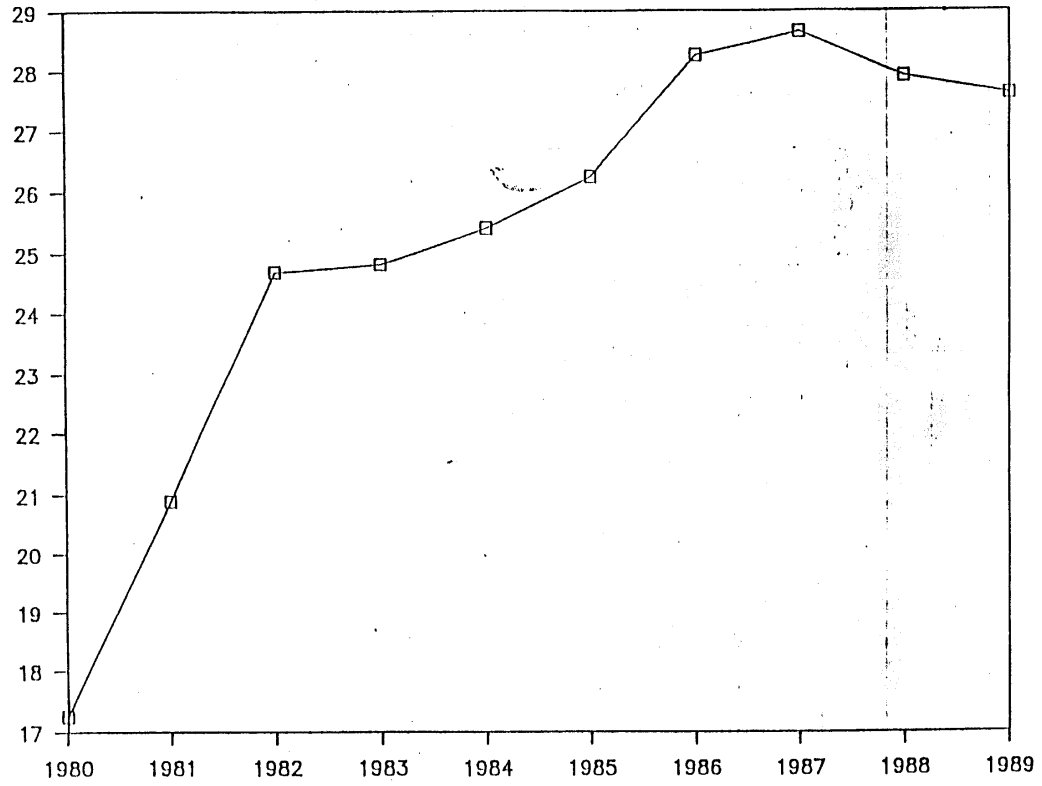

Figure 11
DEBT BURDEN TO EXPORTS
1980-1989

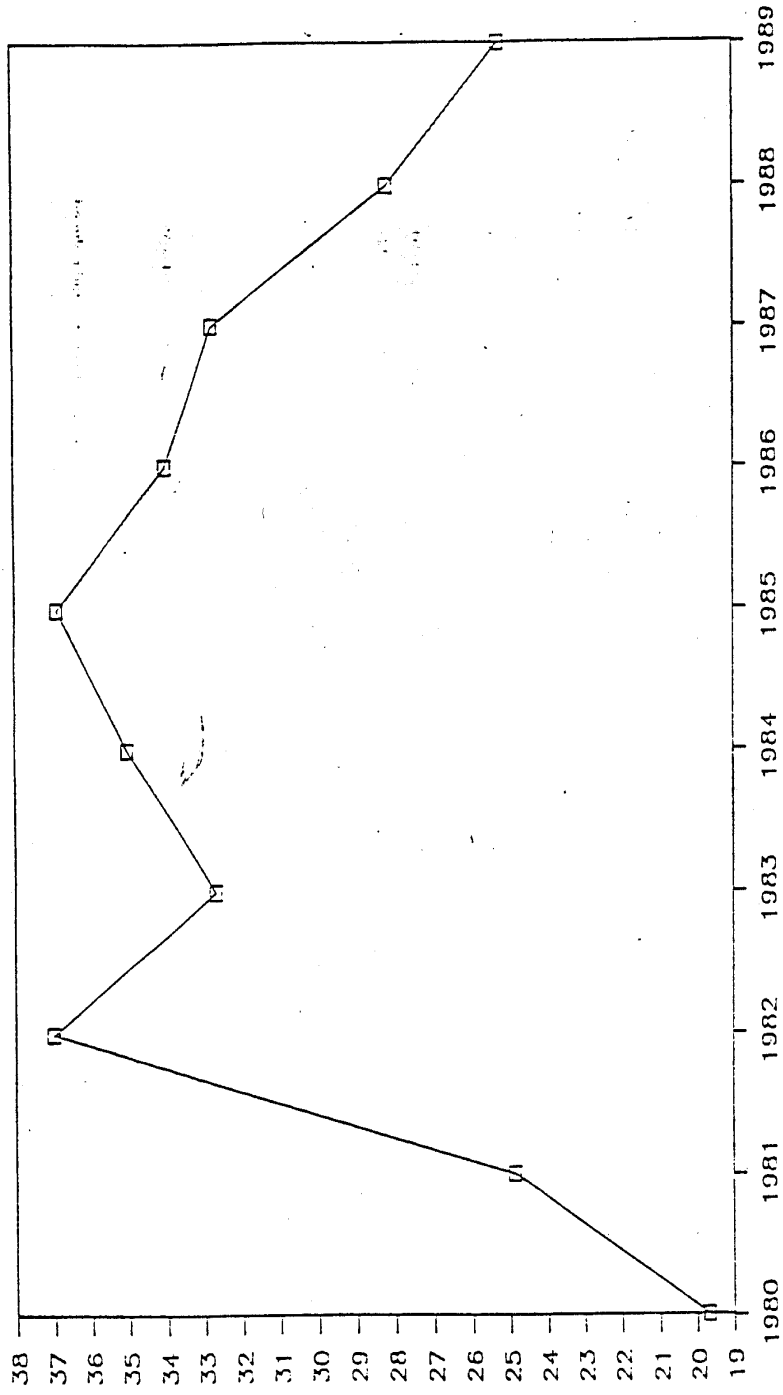

Table 3
NET TRANSFER OF RESOURCES*
(1980-1989)

	1980	1981	1982	1983	1984	1985	1986	1987	1988	1989
A. Total Outflows	1671	2168	3049	3163	3563	2849	3205	3199	3186	3328
Debt Service Burden										
Amortization	696	794	1059	1178	1233	641	1117	1092	994	908
Interest Payments	975	1374	1990	1985	2330	2208	2088	2107	2192	2420
B. Total Inflows	1974	2283	2533	2718	1343	1699	1864	1363	1230	1937
C. Net Resource Transfer (B)	303	115	-516	-445	-2220	-1150	-1341	-1836	-1956	-1391

*Figures for 1983-1985 were based on IMF concept of arrears, net rescheduled principal amounts, and debt converted to equity and reduced through various schemes.

Source: Central Bank of the Philippines

higher spending due to economic shocks experienced over the past years, delays in the implementation of revenue measures, shortfalls in receipts of foreign grants and asset sales, substantially higher-than-expected domestic interest rates, and spending overruns in some areas.

Interestingly, debt service accounts for a disproportionately large share of total government outlay in the last three years. On a per capita basis, however, government expenditures adjusted for debt service and net lending in 1988 is lower than its pre-crisis peak level in 1981 (Yap 1990). This regressive nature of the expenditure policy is expected to continue for as long as the debt service remains a large part of the government outlay.

There has been a shift in the major source of financing the deficit. Although net foreign borrowing was important in the early 1980s, domestic sources were largely used in the subsequent years. Over the period 1986-1990, net domestic financing funded 71 percent of the national government deficit. The increased domestic borrowing added pressure on domestic interest rates which subsequently put downward pressure on private investment and growth.

D. Monetary and Banking Policy

Measures have been implemented to strengthen the banking industry, improve the rural credit market, and promote competitiveness in the financial system. These included the shift to a market-oriented credit policy, the relaxation of the deposit retention scheme, the reduction of barriers to bank entry and branching, the rehabilitation of the rural banking system, and a more active role for the Philippine Deposit Insurance Corporation (PDIC). However, efforts at reducing costs in financial intermediation were slowed down by the failure to abolish the agri-agra requirements and the gross receipts tax. Moreover, reserve requirement on deposit liabilities of banks was raised by two percentage points in December 1990 which further increased the cost of funds.

Monetary policy has been expansionary in the last two years despite calls for a more prudent stance (the target growth rates for broad money in the Adjustment Program overshoot by more than 80 percent). The Central Bank seems unable to implement its monetary policy. When the budget deficit surged, the government withdrew substantial amount of its deposits from the Central Bank, thereby causing a much larger increase in money supply. Given the current setup, monetary policy will likely remain subservient to fiscal policy as long as fiscal deficits remain high.

E. Trade, Industrial and Agricultural Policies

In 1981, trade reforms were initiated with three major components: tariff reform aimed at reducing the maximum rate of duty from 100 percent to 50 percent, import liberalization, and indirect tax realignment with the objective of eliminating the protective element of local indirect taxes. The tariff reform program led to the reduction in the average nominal tariff level from 41 percent to 28 percent. Import restrictions were likewise lifted on 1,477 Philippine Standard Commodity Classification (PSCC) lines; this reduced the number of regulated items from 34.1 percent of the total number of PSCC lines in 1985 to 8.0 percent by the end of 1989. Except for logs, all export taxes were also abolished.

Efforts toward industrialization have been hampered by the lack of an overall industrialization program. Instituting the investment incentives in the 1987 Omnibus Investment Code and initiating an Investment Priorities Plan would have resulted in more success stories if only they were implemented within a coherent industrialization strategy, has been haphazardly implemented since “the decision making process in this area has degenerated into efforts at self-protection for firms with access to political power (Montes 1988).

The liberalization program is intended to have positive effects on agricultural development. Specifically, the reduction or elimination is intended to have positive effects on agricultural inputs would consequently reduce production costs to farmers. To date, the Aquino government successfully eliminated the fertilizer cartel. Likewise, proposals from the agriculture sector have been passed to exempt fertilizer and other intermediate inputs from the nine percent additional import levy recently initiated in consonance with the new arrangement with the IMF.

Policy reforms were also undertaken to promote market efficiency in the agriculture sector, namely, the elimination of trading monopolies and the privatization of trading activities particularly of wheat, flour, and soybean.

Lastly, as the much-touted centerpiece of the Aquino administration, the Comprehensive Agrarian Reform Program received much less support and achieved much less success than it deserves. Administrative, financial, and political problems have so haunted the program ever since it was launched that there is a growing public skepticism about the government’s commitment to this undertaking.

On the whole, some positive results arose from reforms undertaken in trade, industrial and agricultural policies; however, these reforms have not completely eliminated the biases against exports and agriculture.

F. Overall Results

A comparison of the actual performance *vis-à-vis* the objectives of the Program for the years 1989-1990 shows that the Philippine economy was way off target in almost all sectors (Table 4). While it cannot be denied that external and uncontrollable factors (such as the December 1989 coup attempt, drought and the resulting power outages, a devastating earthquake, and the Middle East crisis) partly affected the performance of the domestic economy, inappropriate policy actions such as external debt and exchange rate management strategies, and policy slippages in the fiscal and monetary sector have further undermined the Adjustment Program. The recent failure of the Philippines to carry out its adjustment program is not unique in its history. There were several adjustment programs in the past that also failed. So far, all adjustment efforts made by the Philippines were all inspired by foreign funding from the World Bank and the IMF.

1. WB-Funded Adjustment Programs

Table 4
Philippines: Objectives and Performance of the Adjustment Program,
198-1992

	1989		1990		1991		1992	
	Target	Actual	Target	Actual	Old Program	Proposed	Old Program	Proposed
(Annual Percentage Changes)								
Output and prices								
Real GNP	6.5	5.7	6.5	3.1	6.5	n.a.	6.5	n.a.
Consumer Prices period average	8	10.6	6-7	14.0	5-6	9.5	5.6	7
Money and credit (annual average)								
Broad money	16.5	29.8	15	28.6 ^{1/}	13-14	n.a.	13-14	n.a.
Monetary base	13	35.4	14	13.7 ^{2/}	11-12	n.a.	11-12	n.a.
(As Percent of GNP)								
Public Finance								
Public investment	4.2	3.9	4.7	n.a.	5.6	n.a.	5.8	n.a.
National govt. deficit	1.6	2.0	0.9	3.6	0.9	1.8	1.4	0.4
Public sector borrowing requirements ^{3/}	2.1	n.a.	1.6	n.a.	1.8	n.a.	2.0	n.a.
Consolidated public sector deficit ^{4/}	3.4	4.1	2.9	5.2	2.5	3.7	2.3	2.5
External								
Current account deficit	2.2	3.3	2.5	5.7	2.4	4.5	2.2	3.5
External debt	66.7	62.4	61.2	n.a.	56.3	n.a.	52.1	n.a.
Debt service (in percent of export goods and services) ^{5/}	33.8	25.2	32.2	n.a.	31.0	n.a.	29.4	

^{1/}As of October 1990.

^{2/}Projected.

^{3/}National government deficit plus deficit of monitored corporations.

^{4/}Combined deficit of the national government and public financial and monitored nonfinancial corporations.

^{5/}After rescheduling

Sources of data: Table 2 of this study.

Business World. January 29-31, February 1-4 1991.

The Philippines obtained several financing arrangements from the World Bank to support structural reforms that were introduced in the 1980s. Both the first and second structural adjustment loans (SAL I and II) were secured in 1980 and 1983, respectively, to support a broad range of structural adjustment program during the period 1980-1985, including tariff reforms, rationalization of indirect taxes, the restructuring of the industrial incentive system, and adjustment in energy prices. The World Bank also approved an industrial finance loan in 1981 to support improvements in financial sector policies, including liberalizing the interest rates, reducing bank specialization, and increasing the availability of longer term funds. In 1985, the Philippines was able to arrange with the World Bank an agricultural loan to support a series of reform in the pricing and distribution of fertilizer, rice, feedgrains, and other commodities. This was accompanied by the agricultural credit project which sought to reform the rural financial markets, specifically phasing out credit subsidies to the agricultural sector and stressing savings mobilization. In 1987, the World Bank granted the Philippines a loan to support its economic recovery loan program. Under the program, the Philippines committed itself to introduce tax reforms (including the switch to value-added tax), trade reforms, rationalization of investment programs, and reforms in the government financial institutions (including the rehabilitation and restructuring of the Development Bank of the Philippines (DBP) and the Philippine National Bank (PNB)). The latest World Bank-supported program is the financial sector adjustment loan program which seeks to strengthen the financial system, particularly the commercial banking segment. Many of these reforms were incorporated in the 1987-1992 Adjustment Program.

2. IMF-Funded Adjustment Programs

In the mid-1970s, the Philippines secured from the IMF a three-year Extended Fund Facility to support structural reforms in three areas: infrastructure investment, tax reform, and resource allocation. The program was completed in 1979 but miserably failed to attain its objectives (Montes 1988). For instance, the tax effort target was never attained even though it was revised downward. In the early 1980s, the Philippines obtained a standby arrangement with the IMF to improve its external position. However, a balance of payments crisis struck in 1983 that made it impossible for the Philippines to fulfill its commitments under the IMF standby program. This prompted the Philippines to renegotiate with the IMF its adjustment program. The 18th standby agreement was secured by the Philippines in 1985. Its objective was to stabilize the economy by reducing the fiscal deficit, lowering the balance of payments gap, and obtaining a restructuring of its external debt. The program appeared successful in correcting the balance of payments problem, but it was achieved at a high price since GNP fell sharply. The standby agreement was followed by a three-year extended arrangement to support the 1987-1992 adjustment program discussed above.

Not feeling any adjustment fatigue, the Philippines is currently negotiating with the IMF for another financing arrangement. This time the program will focus on stabilizing the economy, although structural reforms initiated in various areas in the recent past will still be continued. Accordingly, the “centerpiece of this program is a strong effort to bring down the overall fiscal deficit through measures to raise revenue...” This, of course, is a familiar tune by now.

The Philippine experience with adjustment programs is not unique in this world. In fact, adjustment programs made by many developing countries with the IMF and the World Bank

have been in a continuing state of amendment and revision. Ranis (1989, 9.17) aptly commented on this process: "It is this tiresome ritual of consultative group meetings, emergency reviews, bridge loans, and occasional weekend crisis meetings that has helped bring us to the present impasse. Paradoxical as it may seem, such predictable, periodic rescue operations tend to drown out substantive policy dialogue, and make real long-term change less rather than more likely."

Going back to our framework, it can be observed that adjustment programs carried out by the Philippines in the past were mainly preoccupied with their impact on macro aggregates and paid very little attention to their impact at the micro level. They still assume that accelerating the growth rate of output will have a "trickle-down effect." Some programs, especially those supported by the World Bank, raised some concerns about the impact of adjustment on poverty and income distribution, yet, went ahead using macro aggregates as indicators of success.

V. **SECTORAL CONCERNS**

This section discusses the sectoral interactions that may provide insights into the factors that may play important roles in understanding the impact of macroeconomic adjustment policies on households. The sectoral issues that are important to households, namely, education, health, nutrition, fertility, and income distribution are discussed. The last section is devoted to a discussion on the households' survival strategies and coping mechanisms.

A. Education

1. Education Problems in Perspective

Deteriorating quality. A review of the long-term performance of the education system of the country shows that while the educational system was able to absorb the school-age population, this was done at the expense of quality. This deterioration is shown by the slow progress in promoting literacy rates and survival rates, as well as the dismal results in standard tests conducted among the elementary and high school students (Herrin 1990).

A large variation of quality exists in the elementary and secondary education within the public school system. One of the cited reasons for this phenomenon is the fact that public secondary schools quality also exists between private and public school as evidenced by the average scores of their respective students in Mathematics, English, and Pilipino. Among the clear differences between private and public schools is the fact that private schools spend more on material inputs such as desk, textbooks, and reference books than on personnel salaries as compared with public school (Paderanga 196).

Educated unemployed. The major problem at the tertiary level is the large proportion of the so-called "mismatch" between training and actual jobs, as well as the corollary problem of large, educated unemployed or underemployed (Arcelo and Sanyal 1987; Domingo 1974). This phenomenon was believed to result from a rational response to a dual labor market where one sector is import-substituting, highly protected, and paying high wages while the other is unprotected and paying of wages. Graduates may choose to wait it out until a job opportunity in the high-paying sector comes. In the meantime, the student can improve his chances of getting a

job in the protected sector by accumulating more credentials. This leads to the proposition that the solution to this phenomenon should not be in the educational sector but in the industrial sector (Paderanga 1990).

Unequal access. In 1988, the government adopted the policy of providing free public secondary education in order to provide low income students greater access to secondary education.

Private tertiary schools operate on a “quality-tuition structure” that promote inequality of access (World Bank 1988). An assistance program for private education as adopted in order to cushion the impact of tuition fee increases by providing subsidy equivalent to the tuition fee increase. This policy has been criticized as devoid of economic justification especially for higher education (Herrin 1990).

2. Impact of Improvements in Educational Status

Education is widely accepted as a factor that makes a person productive both in the labor market and in the household (Welch 1970). But this belief has been challenged by the observation that education does not improve productivity but merely serves as a proxy for the unobservable characteristics that make a person productive (Arrow 1973).

Another recognized benefit of education is that it enables an individual to deal with a disequilibrium situation much more efficiently (Schultz 1975).

In a study of sixty countries, it was found that returns to schooling in developing countries were at least as high as any social discount rate. The returns were also seen as highest in primary education and lowest in tertiary education (Psacharopoulos 1988).

Expansion of the educational system was seen as a contributing factor in reducing the dispersion of earnings, thereby enhancing equitable distribution of income. This equity effect is also highest with the expansion of basic education but may be regressive with university level education (Psacharopoulos 1988).

In less developed countries where technologies are imported, education contributes to the choice, absorption, dissemination, and adaptation of appropriate technology (Oshima 1988).

3. Determinants of Educational Status

The educational outcome is seen as a result of the interaction between the household's demand for education and the available educational services. The socioeconomic determinants can be grouped into four: household characteristics, school characteristics, and community characteristics.

In a study of the determinants of school quality or schooling achievement measured by average scores in Mathematics, English, and Pilipino, material inputs such as number of desks, number of reference books per student, and maintenance less textbook expenses appeared to be

significant positive determinants (Paderanga 1986). However, these material inputs should also come with qualified teachers to use them (Lockheed *et al* 1987).

B. Health

1. Health Problems in Perspective

Slowdown in health status improvement. The deteriorating health status in the 1970s resulted from several factors: the low level of health care services utilization, the slow-down of fertility decline starting 1975, the association of high fertility rate with high infant and child mortality and the poor environmental sanitation as indicated by the high incidence of parasitism among children. One indirect factor contributing to this phenomenon is the increase in the proportion of households below the poverty line (Herrin 1990).

Inappropriate Policies. A litany of inappropriate policies in the past provides insights toward understanding the problem discussed above. These policies include: the low priority given to the health sector in terms of budgetary allocation, non-consideration of disease patterns in designing the structure of health care services, failure of health programs to focus on high impact groups that have little or no access to basic health services, and the disregard for efficiency considerations in the delivery of health services (Herrin 1990).

There are recent attempts toward correcting these inappropriate policies. For example, the budget share of the Department of Health has been increased substantially. There is also a greater emphasis for basic health care services (Herrin 1990).

2. Impact of Improvements in Health Outcomes

A review of empirical studies on the consequences of improvements in health status on income showed conflicting results. These led to the conclusion that the otherwise conceptually sound link between improved health and greater productivity and wealth have a “mixed and uncertain” empirical support (Gwatkin 1983; Andreano and Helmeniak 1986). Some arguments were presented to explain this result. One, the route from ill-health to income is a long and mediated one. Health status affects functional capacity, then functional capacity affects productivity, before productivity is translated into income. The translation of productivity into income depends critically on the economic and institutional context. Two, households learn to cope with the consequences of adult ill-health so that the household level studies would likely underestimate the impact (One *et al.* 1990).

Few studies have been done in the Philippines on the analysis of the consequences of better health status. Paqueo (1985) did a multivariate analysis of the effect of illness on the educational attainment of elementary-aged (7-12 or 7-13) children using the 1982 Household School Matching Survey. His results indicate that after controlling for various child, socioeconomic, demographic, and community characteristics affecting school access and job opportunities, poor health status of children (e.g., child has a chronic or persistent disease) significantly reduced their educational attainment (highest level of schooling).

Herrin (1986) drew some insights based on the analysis of the perceived social and economic impacts of schistosomiasis. The perceived social impacts include, pain, stigma, and the longer-run problems of marriage prospects, social mobility through marriage, and longevity. The perceived economic impacts include hampering economic mobility and labor supply. The adverse effects on home production of mothers and school performance of children are also mentioned.

A neglected dimension is the impact of adult ill-health. Among the initial ideas presented in this area are that: (1) children bear the bigger burden of adult ill-health, and (2) households have coping mechanisms to mitigate the impact of adult ill-health but these mechanisms are costly both in the short- and long-run (na *et al.* 1990).

3. Determinants of Health Outcomes

The multivariate analysis of Martin *et al.* (1983) using the 1978 Republic of the Philippines Survey (RPS) showed the following: child mortality risk is significantly higher among children born to mothers aged less than 20 years, lower among first births compared with those in the higher birth order, and lower in homes with sanitary facilities (toilets being inside vs. outside the house or none).

Zablan (1986) used the 1983 National Demographic Survey (NDS) to relate in a bivariate analysis breastfeeding and infant survival. It was shown that a higher proportion of infants survived up to the first year among the breastfed than among the non-breastfed infants. Highest survival rates were found among breastfed children where water supply source is piped water and lowest among the non-breastfed with surface water supply; highest among breastfed children with sanitary toilets and lowest among non-breastfed children who have no sanitary toilets; highest among the breastfed and immunized and lowest among those who had neither, and highest among breastfed children with prenatal care and lowest among those who had neither.

Herrin and Paqueo (1985) estimated a multivariate relation between macroeconomic variables such as employment rate in full time equivalents, real price of food, real per capita personal consumption expenditure, and real cumulated per capita health expenditures; and an adjusted time series estimate for the life-table infant mortality probability (q_0). The life-table infant mortality probabilities were computed using the infant mortality rate (IMR) based on the vital registration and censuses (reported by the Disease Intelligence Center of the Ministry of Health) adjusted for underenumeration and differences in definition between (IMR) and q_0 using the estimates in Fleiger *et al.* (1981). The multivariate relation revealed that infant mortality rates are positively related to the real food price and negatively related with all other variables.

Martin *et al.* (1983) showed that child mortality is negatively related to the parents' education, specifically the mother's. The presence of electricity in the household, which the authors considered a reflection of higher household income and community development, is associated with lower infant mortality. Higher survival rates were also found in urban settings after controlling for other socioeconomic factors.

Herrin (1984) showed that child survival, defined as the proportion of surviving children ever born to women aged 35 or less, is positively related to mother's education, rural residence, and the number of years the community had electric service.

Using the 1981 National Health Survey data, Ching (1989) studied the determinants of the demand for health services among children and adults (15 years and above). The study revealed that quality of service, as measured by the time accorded by physicians, have positive influences on the choice of private facilities. The higher the income, the lesser the probability that a child will be sent to a government facility. This response was construed to indicate that government facilities are of low quality. It was also found that, within a lifespan, adults reduce their use of government facilities and increase their use of private facilities. This implies that either families invest more on numbers who have higher perceived economic value, supporting the human capital theory, or that government facilities cater to the medical needs of the young rather than the aged.

The demand for health care was found to be price inelastic except for some regions. This elasticity does not also increase as income falls, as is usually believed. These results do not support across-the-board changes in prices or subsidies (Ching 1989).

In a study of the health impact of housing and environmental conditions, Solon (1989) concluded that as much as forty percent of the children's health status is explained by housing and environmental conditions. The housing attributes that are important besides the quality of the roof and floor are housing congestion, presence of human and animal waste in the home environment, presence of stagnant water, and the quality of sewers. Another important result of the study indicated that housing attributes valued most in the market are not necessarily the same as those that matter most with respect to household health. Similar results were also found in an earlier study using the household data collected for the Population, Resources, Environment and the Philippine Future (PREPF) project (Layo 1977). This study showed that the quality of water and the quality of ventilation were important factors in total illness. These factors, together with quality drainage, were also found to be significant factors in chronic illness.

The study on the determinants of drug utilization (Ginson-Bautista 1989) of households revealed that perceived morbidity factors explained a lot of the variation in drug use. This implies that medicines were demanded for their curing and alleviation function rather than their preventive role. Another important factor that determines drug use is the presence of health services.

A study on morbidity was able to establish the following results: (1) age is the most significant positive factor of morbidity, (2) traditional beliefs have a positive relationship with chronic illness, (3) education of mothers beyond elementary schooling has a negative effect on total and chronic illness, (4) per capita income did not have a significant effect on any of the morbidity measures, and finally (5) a higher morbidity rate for total or acute illnesses is found in urban compares with rural areas (Layo 1977). Another study established that the income effect of the mother's labor force participation reduces the probability of fever and diarrhea of children below 7 years of age (Garcia 1990).

These studies suggest that the most consistent household socioeconomic determinant of child survival is mother's education. The urban environment, after controlling for other socioeconomic factors, also over time can be explained by food prices, public health expenditures, employment, and personal consumption expenditures.

C. Nutrition

1. Nutrition Problems in Perspective

Malnutrition continues to be one of the leading causes of death especially among children. The special focus of this concern will always be infants and preschoolers.

2. Impact of Improvement in Nutritional Status

Existing studies provide no clear conclusion of whether nutrient intake has a significant impact on health indicators. This assessment is explained as resulting from the following factors: (1) increased nutrient intake partly contributes to increased productivity; (2) up to a limit, human metabolism adjusts in response to nutrient intake; (3) the large personal variation in nutrient intake over time results in doubtful relevance of current intake to health indicators; (4) simultaneously problems; and (5) the anthropometric and self-reported health indicators used are poor proxies of health status (Behrman, Deolalikar and Wolfe 1988).

The impact of nutrients on labor productivity and wages is saddled by problems of controlling for the possible simultaneous impact of labor productivity and wages on nutrition through income (Behrman, Deolalikar and Wolfe 1988).

One of the well-appreciated impact of better nutrition, especially among children, is its association with good performance in school (Selowsky and Taylor 1973).

The impact of nutrients on fertility is seen not in biological but in the behavioral sense such as more frequent intercourse (Behrman, Deolalikar and Wolfe 1988).

3. Determinants of Nutritional Status

Taking the traditional demand-supply framework, one would automatically think of prices and incomes as the principal determinants of nutrient intake. Prices and incomes, however, are affected by many household variables that complicate these standard relationships. Prices are always expressed in terms of food items, which have varied content, rather than by nutrient content. Price of nutrient intake includes not only the price of food item but also the time spent in preparing the food which is, in turn, a function of wages foregone. Educational status of the one preparing the food determines not only the wage rate but also his ability to find and prepare nutritious food. Income, on the other hand, is also determined by nutrient intake in so far as the latter is a determinant of labor productivity.

An increase in the price of food is expected to have adverse effect on nutrient intake. This conventional wisdom, however, has to be quantified by the following conditions under which

this effect may not be observed: (1) if the particular food is nutritionally inferior to its substitutes, (2) if the demand for that food is price inelastic and foods are nutritionally similar, (3) if consumers are compensated for their loss in real income, and (4) if the household produces and consumes that particular food (Behrman, Deolaikar and Wolfe 1988).

Estimates and price elasticities of food items using the 1978 Survey of the Food and Nutrition Research Institute (FNRI) reveal substantial price elasticities (Quisumbing 1985). Staple foods (rice, corn, and fish) are not as price elastic as nonstaples and luxury items such as meat, egg, milk, and milk products. Price elasticities also decline for sugar, fruit, and vegetable group; fish and seafoods; and meat as one moves from the lower to higher income quartiles. The price elasticity of rice and starchy foods first rises up in the second quartile before it goes down for higher income groups. The opposite behavior is obtained for corn/corn products, other cereal products, and eggs. This phenomenon was construed by Quisumbing as an indication of the existence of a wider range of affordable substitutes among energy foods once income reaches the second quartile level.

The expenditure elasticities also vary across food groups and across income groups. Among the energy foods, the elasticities for other cereal products, fats/oils, and sugar are higher than those for rice, corn and starchy food. Fish and seafoods are less expenditure elastic compared to poultry, milk, eggs and meat. These indicate that fish and seafoods are considered staples together with rice, corn, and starchy food. Across income groups, there is a monotonic decline of expenditure elasticities for rice, sugars, and fish as one moves from lower to higher income groups (Quisumbing 1985).

The expenditure elasticities for food was found to be twice the elasticity for calories, indicating a large quality elasticity even for poor households. This implies that as income rises, households buy more expensive food, so that food expenditure increases but the nutrient content of these foods does not increase proportionately (Garcia 1990). Earlier estimates also yielded similar results. In particular, an estimate of the income elasticities of per capita nutrient intake reveals low values ranging from .04 to .1 (Ybanez-Gonzalo and Evenson 1978). This result was corroborated by Wolfe and Behrman (1983). Thus in a recent interview proposed that as income increases, food expenditure increases but this is due largely to food attributes rather than nutrient content (Behrman, Deolaikar and Wolfe 1988).

Paqueo (1977) was able to establish that there is a threshold income below which the nutritional status of preschoolers may tend to deteriorate as their parents acquire more income.

Other household factors that determine nutrient intake are labor force participation, education of mothers, and time spent in preparing food. Mothers' education was found to be positively related with average calorie intake (Popkin 1980), and this response was found to be substantial and robust (Behrman, Deolaikar and Wolfe 1988). The increase in child care time of mothers increases the nutritional status of children while the increase in child care of older children does the opposite (Popkin 1980). Working mothers in poor households were associated with decreases in per capita intake of protein calories and vitamin A, and increases in the per capita consumption of starchy staples (Ybanez-Gonzalo 1976). Time spent on preparing food significantly increases the nutrient intake adequacy (Valenzuela 1978).

A recent study (Garcia 1990) of individual food consumption among low income groups in three provinces (Abra, Antique and South Cotabato) revealed that the net effect of the mother's employment is negative on the short-run nutritional status as measured by a higher risk of children being underweight. The negative effects of lower quality child care appears to dominate the income effects gained from mother's market work. On the other hand, an increase in women's wages reduces the probability of child stunting, which is an indicator of long-run nutritional status.

Some interesting results in intra-household food allocation were also documented. Young girls were found to receive less food in relation to their requirements than young boys. Adults also received a higher percentage of their required calories than do young children. An increase in wage rate of the wife and mother increased the allocation of calories to herself and her children while the opposition happened if the wage rate of the husband increase (Garcia 1990). Two implications can be derived from these results. One human capital theory is supported because those perceived to be economically more important (i.e., adult *vis-à-vis* children) were given preference. Two, the preference of the income earner is reflected (i.e., mother with herself and the children, father for himself).

A study (Bouis 1990) of the demand for calories concluded that even under a moderate growth in the aggregate economy, if real wages are falling, the incidence of malnutrition may increase. Where cereal consumption is derived from subsistence production, i.e. in rural areas, a cereal price reduction may also reduce cereal consumption and increase consumption of relatively expensive sources of calories.

D. Income Distribution and Poverty

1. Distributional Impact of Adjustment Policies

Although there may be agreement on the need for structural adjustment due to unsustainable macroeconomic policies and the resultant macro imbalances, there is lately a concern about the impact of adjustment policies on income distribution and poverty, and in particular on vulnerable groups. Heller et al. (1988) noted that IMF-supported adjustment programs have been criticized "for seeking excessive reduction in aggregate demand, thus resulting in an unwarranted contraction of output, employment opportunities and living standards of poverty groups." In a study of seven developing countries (Chile, Dominican Republic, Ghana, Kenya, Philippines, Sri Lanka and Thailand), Heller argues that although the adjustment policies may have undesirable distributional effects, these policies are necessary to safeguard the long-term interests of the poor from the adverse impacts of domestic or external shocks. However, the adverse impact of some macroeconomic policies on poverty groups was acknowledged. Some examples are the adverse impact of (1) devaluation in countries like Chile, Dominican Republic and the Philippines, with large urban poverty groups; (2) cuts in health and education expenditures accruing to the poor (Kenya, Sri Lanka, Philippines); and (3) restrictive monetary policies on employment opportunities and earnings of urban poverty groups in the short-run (Philippines). In particular, the same study concluded that the adjustment measures reflected in the 1983 and the 1984-85 stabilization programs in the Philippines, as well as those

adopted outside the stand-by arrangements, adversely impacted on the poor in the short-run (Heller *et al.* 1988).

Similar sentiments were expressed by several quarters (Cornia, Jolly and Stewart 1987; Cornia 1987a; Ribe *et al.* 1990; and van de Walle 1990) but it has been acknowledged that the effects of adjustment policies on relative income distribution is complex and fraught with conceptual and practical difficulties. An attempt by Ahluwalia and Lysy (1981) showed that the effect of a contractionary stabilization policy will depend partly upon the elasticity of substitution of capital and labor, with low elasticities increasing the share of labor but between different categories of laborers and capitalists. They noted that credit restriction policies may hurt the small informal sector firms and the rural sector whereas cuts in various consumption subsidies may hurt the poor, regardless of their source of income.

Cornia (1987a) noted that most of the discussion about income distribution centers on the question of functional distribution of income, and largely ignores the fact that many developing countries have large informal and/or non-monetized sectors, for which the usual concepts of functional income distribution lacks relevance. Data on the size distribution of income whether by individuals, households, or by socio-economic groups are seldom available. Thus, in an economy with a significant informal sector, the principal question is whether inferences made from official statistics alone adequately and accurately reflect all the economic channels of adjustment policies (Heller *et al.* 1988).

A deeper problem lies in the difficulty of distinguishing the impact of adjustment policies from those of the structural and policy problems that the adjustment policies seek to address (Ribe *et al.* 1990). Numerous and complex channels exist through which the poor are affected (Heller *et al.* 1988). Furthermore, varying economic structures, social stratification, and the differentiated impact of expenditure-reducing and expenditure-switching policies on different households and data constraints present serious hurdles to empirical estimation.

2. Analytical Methods Used to Measure Impact on Equity

Several studies examine the impact of adjustment policies on macro variables (e.g., balance of payments, inflation, growth), but only a few studies attempt to assess their sectoral and distributional implications. The limited evidence comes from some case studies (those done by the Overseas Development Institute, the World Bank, and specific country studies) that follow at least two approaches as identified by Thorbecke (1988): (1) the first one takes various components (measures) of the adjustment package like devaluation and fiscal instruments of adjustment effects into different categories defined on the basis of mechanisms through which they affect the poor. He identified five ways through which the impact on equity can be determined: (1) access of poor groups to productive assets, (2) rate of return on assets held by the poor, (3) employment, (4) access of the poor to human capital, and (5) income transfers. Concrete country experiences are then reviewed under each heading. An example is the successful experience with land reform in northeast Thailand (Chalamwong and Feder 1988). Under the adjustment program, the farmers security of tenure was enhanced by changing the land classification from forestry to permanent agriculture and by issuing "right to farm" certificates to farmers cultivating land illegally.

Another method to determine impact on equity is through a documentation of impact using comprehensive and detailed household surveys as was done by Glewwe and de Tray in the Ivory Coast in 1987. Welfare levels of households were measured by adjusted per capita consumption levels their effort was part of the Living Standards Measurement Study (LSMS) established by the World Bank in 1980 to explore approaches to improve the type and quality of household data collected by statistical offices in developing countries. They concluded that many of the poor may be little affected by structural adjustment policies because poor households are rural and they are often well-insulated against shocks due to adjustment efforts.

Other analytical methods involve simulations using econometric models reconstructing both policy and outcome variables and their causal processes (Cornia 1987a). Dervis *et al.* (1982) used a general equilibrium model to analyze the effect of alternative adjustment policies. Three archetype economies were specified: primary product exporter, manufacturing exporter, and “closed” economy. In all these economies, devaluation leads to an improvement in the income share of smallholders. However, in the closed and manufacturing economies, devaluation-induced increase in prices reduces the real incomes of marginal agricultural laborers and unorganized urban workers. In the primary-exporter economy, the real income of the agricultural sector increases. Organized labor in the closed and primary-exporter economies retain their position as they index wage demands. However, the income share of capitalists increases in the manufacturing economy at the expense of organized labor. It is interesting to note that these simulations show the complexity of distributional effects that must be balanced against one another to reach conclusions on devaluation’s distributional effect (Demery and Addison 1987a).

On the other hand, Demery and Addison observed that:

1. Analysis using simple policy-on/policy-off time series comparisons are inadequate because of the failure to show causation and the transmission mechanisms. We note that this technique involves the examination of the changes in the value of a given variable in adjustment-and-non-adjustment programs. Still, another approach that seems to share the same weakness is the before-after analysis by which changes in variables are compared before and after the adjustment program.
2. System-wide methods like the Taylor (1983) macro model and the CGE models of the Dervis *et al.* offer a technique to simultaneously account for the impact of different policies. In Taylor (1983), an Indian model based on a social accounting matrix (SAM) was constructed. The SAM represents the base solution of the general equilibrium model since the parameters of the model’s equations are calculated to make their numerical solution agree with the SAM. The model is then used to address income distribution questions. The main weakness of these system-wide methods lies in their inability to analyze within-group changes in income distribution. They, therefore, predict insignificant change in overall income distribution arising from adjustment policies because their simulations account for between-group changes (see Dervis *et al.*, 1982).

3. In-depth studies at the community and household levels are necessary to examine “coping mechanisms” such as migration and income transfers through which the poor try to shield themselves from the impact of the changing economic environment. It is interesting to note that the macro models and other economy-wide models do not capture the corresponding survival or coping strategies that households adopt in view of declining incomes and a deteriorating economic environment.

E. The Impact of Adjustment Policies

1. Impact of Adjustment Policies on Educational Status

Given the foregoing discussions, adjustment policies that cause a decline in public expenditures on education will have a clear impact on an already deteriorating quality of public schools. Since the trade-offs will be much more pronounced in a tight budget situation, the promotion of better primary education should be a clear priority.

The “quality-tuition structure” of the private schools will deny low-income groups access to quality education. Economic contraction due to adjustment programs will exacerbate this type of deprivation.

In terms of the household determinants of educational attainment, evidence shows that private motivation will likely fan inequality problems as research results reveal that the important household determinants of schooling include parents’ education and land wealth which are attributes of the well-off.

2. Impact of Adjustment Policies on Health Outcomes

The foregoing discussions point to the helplessness of vulnerable groups against economic contraction that may be brought about by adjustment policies. Since the educational attainment of the mothers of these households is likely to be low, the effects of economic deprivation may likely be exacerbated and low income families will be hit hard by adjustment policies.

3. Impact of Adjustment Policies on Nutritional Status

Given the varied price elasticities of different food groups and their varying behavior across income groups, any price increase would clearly bring differential impact among the different population subgroups. This means that some gain nutritionally from the adjustment while others lose. This implies that across-the-board subsidies will have differential nutrition impact too.

The direct impact of income on nutrient intake ought to be further examined in the light of the initial results implying that income may have a very limited effect on nutrient intake. But there are indirect effects of income such as the increased labor force participation of mothers in the face of reduced income. This will have a clear negative impact on nutrient intake. The

substitution of older children for the mother due to the latter's participation in the labor market was also found to have negative impact on nutrient intake.

4. Impact of Adjustment Policies on Income Distribution and Poverty

Recent attempts to vary the impact on distributive equity is rather mixed. Cornia (1987a) cited studies of Foxley (1981), and Pastor (1986) which showed that IMF-style programs were significantly associated with declines in the wage share. In contrast to Killick (1984), Addison and Demery (1985), and Helleiner (1987) found that there is no available evidence linking IMF-supported adjustment programs with worsening relative income distribution compared with any practical alternative. For Cornia and the United Nations International Children's and Emergency Fund (UNICEF), however, the more important and crucial issue is the effect of adjustment policies in terms of overall poverty rates. A study by Altimir (1984, cited in Jolly and Cornia) documented a sharp increase in poverty in Costa Rica following a substantial decline in GDP from 17 to 29 percent between 1979 and 1982. The conclusion made by Cornia is that, on the average, there is a tendency for adjustment policies to have an adverse effect on poverty levels.

In the Philippines, there seems to be a dearth of studies on the distributional and poverty impact of adjustment policies. The principal effort was done by Herrin (1986 and other local studies cited in our review) and UNICEF, Manila (1988). But these studies were hampered by limited and sometimes, inadequate data which, when available, covered different periods and were derived from limited samples. Balisacan (1990), however, had some impressionistic observations on the Philippine experience with adjustment policies: that the negative impact on the poor was greater than other members of society and that the poor who have at least specific skills were the first ones to be most adversely hit by the reduction in economic activity. Using a CGE model for the Philippines, Bautista and Montes (1990) analyzed the impact of adjustment policies on the distribution of product and income. The study showed that a devaluation results in a decline in total household incomes, a decline in urban income, an increase in rural income, and a decline in labor income.

F. Survival Strategies and Coping Mechanisms of Households

Households adjust in response to changes in their economic conditions and opportunities. While ordinarily these changes may be expected to occur in the medium term as economic conditions and opportunities unravel, significant short-term changes in their livelihood strategies are observed when rapid deterioration in economic conditions and declining opportunities arise. Altimir (1984) documents the movement of different socioeconomic groups within the income pyramid and the changes in these groups' livelihood strategies in Chile, Columbia, Costa Rica, Panama and Venezuela. Table 5 summarizes the different survival strategies and coping mechanisms employed by different households in reaction to sharp declines in economic fortune. Cornia (1984) however observes that despite the many village-level poverty studies, very little is known about the mechanisms and strategies households employ in order to survive under conditions of want and deprivation. Only broad fragmentary evidence is available and the documented survival techniques are those under the three general categories shown in Table 5. In

Table 5
SURVIVAL STRATEGIES OF HOUSEHOLDS

1. Strategies aimed to generate resources:
 - a. Increasing the supply of labor to the economy
 - b. Increasing self-production
 - c. Changing assets-liability position
 - d. Increasing the flow of income transfer
 2. Strategies to improve the efficiency of existing resources:
 - a. Changes in purchasing habits
 - b. Changes in food preparation habits
 - c. Changes in overall consumption patterns
 - d. Changes in dietary patterns
 - e. Changes in intrahousehold food distribution
 3. Extended family and migration strategies:
 - a. Changes in the household composition and organization
 - b. Migration
-

Source: Constructed from the discussion of Cornia (1988b).

the Philippines, Herrin's (1987) study of the urban poor in Cebu and Davao identified four response mechanisms. These consist of: (1) increased labor force participation of spouses and other adult members; (2) reduced schooling participation of children; (3) reduced consumption expenditures, especially on food; and (4) desire to limit the number of children. The first strategy attempts to restore the sagging income of the household head due to declining real wages or even outright layoff. The squeeze in economic resources gives rise to the second and third responses. The reduction in real income means significant readjustments in consumption patterns with serious implications for nutrition, health, and education especially for children. The last one may be a consequence of bleak expectations about future economic conditions.

The second set of evidence was gathered by the Food and Nutrition Research Institute (FNRI) from case studies of Metro Manila households (Valdecanas 1984). An interesting dimension is the distinction between households whose heads were laid off for four to six months and those whose heads were still actively employed at the time of the inquiry. On non-food items, the adjustment of the two groups did not differ. But on food expenditures (with energy and protein adequacy levels for the two groups remaining identical), the "Laidoff" groups consumed more rice, perhaps to compensate for inadequate protein intake.

VI. DATA AVAILABILITY AND MICRO LEVEL MONITORING SYSTEM

This section discusses data sources and availability, as well as the micro level monitoring system needed to track the impact of macro policies on household welfare.

A. The Philippine Statistical System

The Philippine Statistical System is composed of the following agencies: the National Statistical Coordination Board (NSCB), a policymaking and coordinating body; the Statistical Research and Training Center (SRTC), the research and training arm of the system; the National Statistics Office (NSO), a general purpose statistical agency; and all departments, bureaus, offices, agencies, and instrumentalities of the national and local government, and all government-owned or controlled corporations and their subsidiaries that are engaged in statistical activities either as a primary function or as part of their administrative or regulatory functions.

The NSO is responsible for generating general purpose statistics and for undertaking censuses and surveys designated by the NSCB. All of the sectoral household surveys that are potentially useful sources of information for understanding the micro impact of macroeconomic adjustment policies are conducted by the NSO, in cooperation with an appropriate partner agency.

There is no formal structure in the Philippine Statistical System that is specifically tasked to monitor the conditions of households as well as micro-production costs under a changing macroeconomic policy environment. The usual procedure for specific-purpose studies is to commission a special survey, an example of which is discussed in a subsequent section. These surveys, however, come only in discrete times and are, therefore, insufficient for the requirements of regularly monitoring the micro impact of macroeconomic adjustment policies.

B. Data Sources and Availability

1. Data on Educational Status

Measures of educational development can be grouped into input-based and outcome-based indicators. Among the first group of indicators are the number of schools, classrooms, teachers, textbooks and other teaching aids per student at each level.

The input-based indicators usually come in aggregate expenditures so that it is difficult to compute for the input-specific expenditure per student. These are specialized surveys such as the Household Schooling Matching Survey or some multi-purpose surveys, but these come in discrete times.

The output-based indicators are regularly reported by the Department of Education, Culture and Sports and regularly reported in the Philippine Statistical Yearbook and specialized publications such as the Economic and Social Indicators.

A household-based benchmark survey called the Household and School Matching Survey (HSMS) for the Program for Decentralized Educational Development (PRODED) was conducted in 1982. This data set was used in many of the household and school-based analysis of educational attainment and school quality.

2. Data on Health Status

Data sources for health indicators include the vital registration systems for death as well as the death and disease reporting system for the Department of Health. These systems, however, are known to underestimate the mortality and morbidity incidence. Specialized surveys such as the National Health Survey provide an alternative but they are costly to administer. A third alternative is indirect estimation from censuses and vital registration data. These data, however, come in discrete time periods and hence, are insufficient for surveillance of changes and trends in health status. The health status data for specialized groups, such as low-income families, are at best spotty.

The National Health Survey is conducted by the Department of Health and the National Statistics Office. Three surveys have been undertaken so far: in 1978, 1981 and 1987.

3. Data on Nutritional Status

The nutritional status of the population is usually described in terms of: (1) energy and protein insufficiency; (2) growth failure, especially among children; and (3) micro nutrient deficiencies.

The National Nutrition Survey conducted by the Food and Nutrition Research Institute (FNRI) is the primary source of comprehensive data on the nutrition of households. Three nutrition surveys have been undertaken so far, one for each of the years 1978, 1982 and 1987.

4. Data On Income Distribution and Poverty

The statistical base for poverty analysis is mainly the various rounds of the Family Income and Expenditure Survey (FIES). These surveys were undertaken in 1961, 1965, 1971, 1975, 1979, 1985, and 1988. The 1975 and 1979 surveys, however, were not published due to some technical problems, one for which was the implausibility of the data generated arising from substantial undercoverage. Excluding 1975 and 1979, it appears that the FIES provides a reasonably good series – and the only one available – for the analysis of trends in income inequality and poverty over the last three decades. Unfortunately, we have only limited published tabulations for 1961, 1965, and 1971 and data tapes are available only for 1985 and 1988 (Balisacan 1990).

5. Other Relevant Survey Statistics

A special socioeconomic survey on low-income families was done by the NSO in 1989. This survey focused on the bottom 30 percent identified in the 1985 FIES and was made for the NEDA study entitled “Study on Government Assistance to Low Income Groups with Inadequate Access to Institutional Credit.”

A very similar survey called Socio-Economic Survey of Low-Income Groups of Families is envisioned to be a regular activity in the NSCB’s Ten Year Statistical program, with a planned frequency of every three years. This survey will determine the demographic and economic characteristics of low income families, skills and employment status of family members, credit information, problems, and access to community facilities and services. This activity will start in 1993.

C. Micro Level Monitoring System

Our review shows the lack of monitoring, information, and feedback system to assess the impact of macro adjustment policies on the micro or household level. There is a regular and timely information on such macro variables as base money, money supply, inflation rate, foreign exchange reserves, trade balance, public debt, external debt, etc.; but the needed “information on the human dimension” to know, infant mortality rates, nutrition levels, or the poverty situation are not regularly tracked. Or if available, these types of information are of doubtful quality and are not collected at regular intervals there is no systematic, routine, and regular collection nor a timely publication of data on the human dimension. The macroeconomic indicators are not capable of capturing changes overtime in household welfare. What are required are more frequent, disaggregated and timely data on the various human dimensions.

Stewart (1987) pointed out that regular monitoring of human status is necessary in order to take stock of the current situation and take appropriate policy interventions. However, this requires a well-functioning system to analyze and feedback on the information collected which is currently unavailable. There is also the glaring failure (or inability) to use, analyze, and publish data already being collected. The required monitoring and feedback system also implies the need

for a clear-cut and definite delineation of authority and responsibility, and proximate access to policy/decision makers.

VII. ISSUES AND RESEARCH GAPS

It is known that at the macro side, adjustment policies are necessary for restored growth which is constrained by the macroeconomic imbalances affecting most developing countries. Our cursory review of literature shows that adjustment policies are directed at the macro variables in the economy. These macro aggregates include the money supply, inflation rate, budget deficit, and the balance of payments. However, the micro implications on the households are rarely addressed as an important and direct issue. We have seen in our analytical framework however, how adjustment policies influence the conditions of households through a variety of transmission mechanisms: (1) the labor market, (2) the goods market, and (3) government expenditure.

Obviously, the study on the micro impacts of macroeconomic adjustment policies is important by itself because of the policies' differential impact on households and the fact that the adjustment process will favor some social groups and adversely affect others. However, empirical evidence and documentation linking Philippine adjustment policies with, but more specifically showing their impact on, household conditions are non-existent or at best fragmentary. What we observe from various micro studies are the objective conditions of households that may have been caused by structural and institutional factors, the growth and development strategy and policies adopted by the economy, the short-term adjustment policies themselves, or an interplay of host of these and other causative factors. Almost all of these micro studies use cross-section data from either large sample surveys done by data from either large sample surveys done by data-collection government agencies or independent small sample studies. The absence of empirical studies on the micro impact of macroeconomic adjustment policies is manifested in the lack of consensus on how to proceed with the latest adjustment program for the Philippines. Technocrats who have been preparing adjustment programs before still confine themselves to macro aggregates as targets of the program, while politicians are talking in terms of the number of health workers, teachers, and agricultural extension workers to be laid off, as well as the number of artesian wells and small irrigation projects to be postponed. There is even no agreement on the kind of compensatory programs to be launched to soften the impact of an adjustment program on the vulnerable ones.

Our findings only serve to underline the importance of conducting an empirical analysis of the micro impact of macroeconomic adjustment policies. The research should be able to isolate the effects of macroeconomic adjustment policies from the effects of other factors such as the external environment. This requires a more thorough analysis of the transmission mechanisms so that the net effects of adjustment policies on households' welfare can be quantified. This will greatly improve our understanding of how specific macroeconomic policies affect household income and nutritional and health status.

There is also a need to study the impact of macro policies on production units. Especially in so far as the micro, small-, and medium-scale enterprises are concerned. These production units are typically labor-intensive; they operate outside the Metro Manila area and have some

potential for a positive response to a changing macroeconomic environment. Almost all of them belong to the “informal” or “underground” economy.

Likewise, the impact of macroeconomic adjustment policies on the environment and the natural resource base cannot be ignored. A successful adjustment program must address environmental concerns. In the past, various production systems in agriculture and industry have been developed and introduced without considering their impacts on natural resources. The kind of development that has taken place has been proven to be unsustainable in the long run. Again, the conduct of empirical studies in this area will greatly help policymakers.

Finally, the regulatory environment within which households and producing units operate should be examined because it is also conditions the impact of macroeconomic adjustment policies at the micro level. As pointed out in Section III, similarly situated countries pursuing similar adjustment programs could have divergences in performance, which could be attributed to difference in their regulatory environment.

The government must be well-informed to be able to formulate the appropriate adjustment policies and, if necessary, compensatory measures for the vulnerable groups. But the main challenge lies in its own commitment to monitor changes in household welfare, the quality of the present monitoring system, data availability, and imaginative interventions. Social statistics are woefully inadequate. Data come from limited samples, are not disaggregated enough, and do not come out regularly and on time. It seems that monitoring is devoted to the impact of the adjustment policies on a limited set of macro variables (performance criteria in the IMF-parlance) and there is very little appreciation of the welfare variables. In addition, the analysis done by authorities seems to focus on “successful” or “unsuccessful” compliance with the IMF conditionalities and never on the microeconomic impacts.

Annex
LIST OF PARTICIPANTS
Consultative Workshop on
MICRO IMPACTS OF MACROECONOMIC ADJUSTMENT POLICIES (MIMAP)
City of Springs Resort Hotel, Los Baños, Laguna
February 11-2, 1991

A. *Government Sector*

1. Mr. Tomas Africa
Administrator
National Statistics Office
R. Magsaysay Blvd.
Sta. Mesa, Manila
Tel. No. 610809
2. Ms. Charlene Ang
Technical Staff
Office of Senator Vicente T. Paterno
House of Senate
Philamlife Bldg., UN cor. Taft Avenue
Manila
Tel Nos 472715; 472740; 472755
3. Ms. Lani Azarcon
Consultant
Department of Agriculture
Elliptical Road, Diliman
Quezon City
4. Ms. Sonia Castro
Director, Bureau of Labor and
Employment Statistics
5. Ms. Merle A. Casuga
Chief, Labor Policy Development and
Evaluation Division
6. Ms. Estrella Domingo
Chief, Agro-Industrial and
Consolidation Division
National Statistical Coordination Board
7th Floor, Marvin Plaza Bldg.
2153 Pasong Tamo Extension
Makati, Metro Manila
Tel. No. 851796; 851778; 868632
7. Mr. Mario C. Feranil
Director for Research
Philippine Institute for Development Studies
NEDA Makati Bldg., 106 Amorsolo St.
Legaspi Village, Makati, M.M.
Tel. No. 855817
8. Ms. Ernie Amor Figueroa
Economic Development Specialist
National Planning and Policy Staff
National Economic and Development Authority
Amber Avenue, Pasig, Metro Manila
Tel. No. 6313712
9. Dr. Cielito F. Habito
Assistant Director-General
National Economic and Development Authority
Amber Avenue, Pasig, Metro Manila
Tel No. 6312186
10. Dr. Ponciano S. Intal, Jr.
Deputy Director-General
National Economic and Development Authority
Amber Avenue, Pasig, Metro Manila
Tel No. 6312195
11. Dr. Agustin L. Kintarnar, Jr.
Executive Director, Legislative Budget
Research and Monitoring Office
House of Senate
OMI Bldg., 20th St. cor. Bonifacio Drive,
Port Area, Manila
Tel No. 493564 to 65
12. Dr. Mario B. Lamberte
Vice-President and Officer-in-Charge
Philippine Institute for Development Studies
NEDA Makati Bldg., 106 Amorsolo St.
Legaspi Village, Makati, M.M.
Tel No. 856798
13. Ms. Lucila Lapar
Research Associate
Philippine Institute for Development Studies
NEDA Makati Bldg., 106 Amorsolo St.
Legaspi Village, Makati, M.M.
Tel. No. 853196
14. Dr. Gilberto Llanto
Executive Director
Agricultural Credit Policy Council
11th Floor, Triumph Building
Quezon Avenue, Quezon City
Tel. No. 984578

15. Ms. Marife Magno
Agricultural Credit Policy Council
11th Floor, Triumph Building
Quezon Avenue, Quezon City
Tel. No. 984578; 980136; 968715
 16. Mr. Preceles Manzo, Jr.
Department of Agriculture
Elliptical Road, Diliman
Quezon City
 17. Mr. Aniceto Orbeta, Jr.
Acting Deputy Executive Director
Agricultural Credit and Policy Council
11th Floor, Triumph Building
Quezon Avenue, Quezon City
Tel. No. 984578; 980136; 968715
 18. Mr. Roy Picart
Department of Environment and
Natural Resources
 19. Ms. Marriel Remulla
Chief, Public and Private Services Division
National Statistical Coordination Board
7th Floor, Marvin Plaza Bldg.
2153 Pasong Tamo Extension
Makati, Metro Manila
Tel. Nos. 8517961; 861778; 868632
 20. Ms. Rita Ramos
Technical Assistant
Office of Senator Alberto Romulo
House of Senate
Room 404, Senate Bldg.
P. Burgos St., Manila
 21. Hon. Mario Taguiwalo
Undersecretary and Chief of Staff
Department of Health
San Lazaro Compound,
Sta. Cruz Manila
Tel. No.s. 7116095; 7116055
 22. Ms. Carmela I. Torres
Executive Director
Institute of Labor Studies
Department of Labor and Employment
5th Floor, DOLE Bldg., Intramuros
Manila
Tel. Nos. 475384; 475296
 23. Mr. Rodolfo Vicera
Assistant Director/Consultant
Congressional Economic and
Planning Staff
House of Representatives
B.P. Complex, Diliman
Quezon City
Tel. No. 9224696
 24. Mr. Felizardo Virtucio, Jr.
Economic Development Specialist
National Planning and Policy Staff
National Economic and Development Authority
Amber avenue, Pasig, Metro Manila
Tel. No. 6313712
 25. Dr. Josef T. Yap
Research Fellow
Philippine Institute for Development Studies
NEDA Makati Bldg., 106 Amorsolo St.
Legaspi Village, Makati, M.M.
Tel No. 857385
- B. Academic / Research Institutions*
26. Dr. Gelia T. Castillo
Professor, Department of Rural Sociology
University of the Philippines at Los Baños
College, Laguna
 27. Prof. Roland Delorina
University of Eastern Philippines
Samar, Leyte
 28. Dr. Alejandro Herrin
Professor
School of Economics
University of the Philippines
Diliman, Quezon City
Tel. No. 989691-95
 29. Mr. Gerard Rikken
Director, Action Research Department
Asian Social Institute
1518 L. Guinto St.
Malate, Manila
Tel. Nos. 595613; 596266; 594376
 30. Dr. Orville Solon
Assistant Professor
School of Economics
University of the Philippines
Diliman, Quezon City
Tel. No: 989691-95

C. *Private/Non-government Organizations*

31. Mr. Demetrio Imperial Jr.
Regional Coordinator for Asia
International Institute for
Rural Reconstruction
Silang, Cavite
32. Mr. Nepomuceno A. Malaluan
Research-Writer
IBON Databank and Research Center
3892 R. Magsaysay Blvd.
Sta. Mesa, Manila
Tel. Nos. 600203; 603983
33. Mr. Horacio Morales
President
Phil. Rural Reconstruction Movement
Kayumanggi Press Bldg.
940 Quezon Avenue
Quezon City
Tel. No. 997919
34. Ms. Patricia Alexander
Senior Research Associate
Conference Board of Canada
255 Smyth Road, Ottawa
Ontario K1H 8M7, Canada
Tel. No. (613) 5263280 (Canada)
FAX: (613) 5264857
35. Dr. M. Biemefeld
Canadian Resource Person
International Development
Research Centre
36. Mr D. De Padua
International Development
Research Centre
37. Ms. Veronica Guzman
Program Officer
Canadian International
Development Agency (CIDA)
38. Mr. Jean-Claude Lorin
Deputy Director, Professional Services
Canadian International Development
Agency
Canadian Embassy
Tel. No. 8159536
39. Mr. Chris MacCormac
Acting Regional Director
IDRC-Singapore
Tanglin P.O. Box 101, Singapore
40. Dr. Pushpamma
Nutrition Unit
International Development
Research Centre
41. Dr. W.R. Spence
Senior Program Officer
International Development
Research Centre
42. Dr. Joachim Voss
Environmental Policy Program
International Development
Research Centre
43. Mr. Alessandro A. Manilay
Agricultural Economist
ASEAN Grain Post-Harvest Programme
P.O. Box 1065 Kasetsart Post Office
Bangkok, Thailand 10903

BIBLIOGRAPHY

- Addison, T. and L. Demery. "Poverty Alleviation and Structural Adjustment." London: Overseas Development Institute. 1986.
- _____. "Macroeconomic Stabilization, Income Distribution and Poverty: A Preliminary Survey." *Working Paper Series No. 15*. London: Overseas Development Institute, 1985.
- Ahluwalia, S. and F. Lysy. "Employment Income Distribution and Program to Remedy Balance of Payments Difficulties." In *Economic Stabilization in Developing Countries*, edited by Cline and Weintraub, 1981.
- Ainsworth and Juan Muños. "The Cote d'Ivoire Living Standards Survey." *Working Paper No. 26*. Washington D.C.: World Bank, 1986.
- Akin, J., D. Guilkey, and B. Popkin. "The Demand for Child Health Services in the Philippines," *Social Science and Medicine* 156 (1981): 249-257.
- Alburo, Florian A. "TNCs and Structural Change in the Philippines." *UPSE Discussion Paper No. 88-11*. Quezon City: University of the Philippines School of Economics, 1988.
- _____. "Philippine Trade Manufactures: Structural Change and Adjustment." *UPSE Discussion Paper No. 85-09*. Quezon City: University of the Philippines School of Economics, 1985.
- Alonzo, Ruperto, and Ma. M.A. Mangahas. "The Informal Sector in Metro Manila: Findings from a Recent Survey." Paper submitted to Asian Regional Team for Development Promotion of the International Labour Organization, August 1989, in New Delhi, India.
- Altimir, O. "Poverty, Income Distribution and Child Welfare in Latin America: A Comparison of Pre- and Post-recession Data." In *The Impact of World Recessions on Children*, edited by R. Jolly and G.A. Cornia. Oxford: Pergamon Press, 1984.
- Andreano, R. and T. Helminiak. "Economics, Health and Tropical Disease: A Review: Paper read at a Meeting on the Economics of Tropical Diseases, Manila, 2-5 September 1986. Photocopy.
- Angeles Marian S. delos and Noela C. Lasmarias. "A Review of Philippine Natural Resource and Environmental Management, 1986-1988." *Working Paper Series No. 90-08*. Makati: Philippine Institute for Development Studies, 1990.
- Arcelo and Sanyal. *Employment and Career Opportunities after Graduation: The Philippine Experience*. Manila: Philippine American Exchange Foundation, 1987.
- Arrow, K. "Higher Education as a Filter." *Journal of Public Economics* 2 (1973): 193-216.
- Azam, Jean Paul, *et al.* "The Impact of Macroeconomic Policies on the Rural Poor." Photocopy. New York: United Nations Development Programme, 1989.
- Balisacan, Arsenio M. "Agricultural Growth, Landlessness, Off-farm Employment, and Rural Poverty in the Philippines." *Working Paper Series No. 91-01*, Research and Training Program for Agricultural Policy, University of the Philippines at Los Baños, 1991.

- _____. "Rural Poverty Alleviation in the Philippines." Unpublished paper. Quezon City: University of the Philippines, 1990.
- Ballasa, Bela. "Adjustment Policies in Developing Countries: A Reassessment." *World Development*, (September 1984) 955-972.
- Bardhan, P. "The New Institutional Economic and Development Theory: A Brief Critical Assessment." *World Development* 17 (1989): 1389-1396.
- Battad, J. "Determinants of Nutritional Status of Preschoolers." *The Philippine Economic Journal* 17 (1978): 154-167.
- Bautista, Carlos and Manuel Montes. "Distribution Effects of Macroeconomic Adjustment: A Final Report: November 28, 1990. An unpublished report submitted to the U.S. Agency for International Development and National Economic and Development Authority, 1990.
- Berg, Elliot, ed. *Policy Reform and Equity: Extending the Benefits of Development*. California: Sequoia Institute, 1988.
- Berhman, Jere. "The Impact of Economic Adjustment Programs." In *Health Nutrition and Economic Crisis: Approaches to Policy in the Third World*. Edited by D. Bell and M. Reich. Massachusetts: Auburn House, 1988.
- _____. "Schooling in Developing Countries: Which Countries are the over- and Underachievers and What is the Schooling Impact?" *Economics of Education Review* 6 (1987): pp. 111-127.
- _____. and A. Deolalikar. "Health and Nutrition." *Handbook in Development Economics*, edited by H. Chenery and T.N. Srinivasan, 1. Amsterdam: Elsevier Science Publishers, 1988.
- _____. And B. Wolfe. "Nutrients: Impacts and Determinants." *The World Bank Economic Review* 6 (1987): 299-320.
- Bouis, Howart. "Evaluating Demand for Calories for Urban and Rural Population in the Philippines: Implications for Nutrition Policy under Economic Recovery." *World Development* 18 (1990): 281-299.
- Cariño, Ledevina V. *An Assessment of Public Administration in the Philippines, 1986-1988*. Working Paper Series No. 90-03. Makati: Philippine Institute for Development Studies, 1990.
- Chalamwong, Yongyuth and Gershon Feder. "The Impact of Landownership Security: Theory and Evidence from Thailand." *The World Bank Economic Review* 2 (1988) 187-204.
- Ching, P. "Factors Affecting the Demand for Health Services in the Philippines." Paper prepared under the Health Policy and Development Program of the Philippine Institute for Development Studies and the Department of Health, 1989.
- Cline, R. and S. Weintraub, eds. *Economic Stabilization in Developing Countries*. Washington D.C.: Brookings Institution, 1981.
- Cornia, Giovanni Andrea. "Adjustment Policies 1980-1985: Effects on Child Welfare: In *Adjustment with a Human Face*, edited by Giovanni Andrea Cornia, Richard Jolly, and Frances Stewart. Oxford: Oxford University Press, 1987.
- _____. "Adjustment at the Household Level: Potentials and Limitations of Survival Strategies." In *Adjustment with a Human Face*, edited by Giovanni Andrea Cornia, Richard Jolly, and Frances Stewart, Oxford: Oxford University Press, 1987a.

- _____. "A Summary and Interpretation of the Evidence." In *The Impact of World Recession on Children*, edited by Richard Jolly and G.A. Cornia. Oxford: Pergamon Press, 1984.
- Cornia, Giovanni, R. Jolly and F. Stewart, eds. *Adjustment with a Human Face*. Oxford: Clarendon Press, 1987.
- Demery, Lionel and Tony Addison. "The Alleviation of Poverty under Structural Adjustment." Photocopy. Washington, D.C.: World bank, 1987.
- _____. "Stabilization Policy and Income Distribution in Developing Countries." *World Development* 15 (1987a): 1483-1498.
- Dervis, Kemal *et al.* *General Equilibrium Models for Development Policy*. Cambridge: Cambridge University Press and World Bank, 1982.
- De Soto, Hernando. "Structural Adjustment and the Informal Sector." In *Microenterprises in Developing Countries* edited by Jacob Levitsky. London: Intermediate Technology Publications, 1989.
- Diokno, Benjamin E. "Fiscal Performance in the 1980s: A Policy Perspective." Paper presented at the 28th PES Annual Meeting, 10 December 1990, at Manila Hotel. Photocopy.
- Dolan, R. and R. Schmidt. "Assessing the Impact of Expenditures on Achievement: Some Methodological and Policy Considerations." *Economics of Education Review* 6 (1987): 285-299.
- Domingo, L. "Measurement of Labor Underutilization among Filipino Male Household Heads: An Application of the Hauser Methodology." Master's Thesis, University of the Philippines, 1974.
- Fields, Gary. "Trade Strategies and the Poor: Adjusting to the New Realities." In *Policy Reform and Equity: Extending the Benefits of Development.*, edited by E. Berg. California: Sequoia Institute, 1988.
- Fleiger, W., M.K. Abenejo, and A.C. Lim. *On the Road to Longevity: 1970 National and Provincial Mortality Estimates for the Philippines.* Master's thesis, Institute of Social Studies, The Hague, 1990.
- Foxley, A. "Stabilization Policies and their Effects on Employment and Income Distribution: A Latin American Perspective." In *Economic Stabilization in Developing Countries*, edited by W.R. Cline and S. Weintraub. Washington D.C.: Brookings Institution, 1981.
- Garcia, M. "Resource Allocation and Household Welfare: A Study of the Impact of Personal Sources of Income on Food consumption, Nutrition and Health in the Philippines." Master's thesis, Institute of Social Studies, The Hague, 1990.
- Ginson-Bautista M. "Determinants of Drug Utilization in the Philippines: A Preliminary Analysis of Household Survey Data." Paper presented during the International Health Policy Conference, The Manila Hotel, 31 July – 04 August 1989.
- Glewwe, Paul and Dennis de tray." The Poor during Adjustment: A Case Study of Cote d' Ivoire." *LSMS Working Paper No. 47*. Washington D.C.: World Bank, 1988.
- Gonzalo, S. "Major Factors Affecting Rural Household Food Consumption." (IEDR Discussion Paper) Quezon City: University of the Philippines School of Economics, 1976.

- _____ and R. Evenson, "The Production and Consumption of Nutrients in Laguna Households: An Explanatory Analysis." *The Philippine Economic Journal* 17 (1978): 36-153.
- Gordon, D. *Theories of Poverty and Unemployment*, New York: Lexiton, 1972.
- Grootaert, Christian, "Measuring and Analyzing Levels of Living in Developing Countries: An Annotated Question." *Living Standards Measurement Study Working Paper No. 24*. Washington D.C.: World Bank, 1986.
- Gupta, Sanjeev and Karimi Nashashibi. "Poverty Concerns in Fund-Supported Programs." *Finance and Development* September 1990, 12-14.
- Gwatkin, D.R. "Does Better Health Produce Greater Wealth? A Review of the Evidence concerning Health, Nutrition, and Output." Unpublished paper. London: Overseas Development Council, 1983.
- Hanushek, E. "The Economics of Schooling: Production Efficiency in Public Schools." *Journal of Economic Literature* 24 (1986): 1141-1177.
- Helleiner, Gerald K. "Stabilization, Adjustment and the Poor." *World Development* 15 (1987): 1499-1513.
- Heller, Peter S., *et al.* "The implications of Fund-Supported Adjustment Programs for Poverty: Experiences in Selected Countries." *Occasional Paper No. 58*. Washington D.C.: International Monetary Fund, 1988.
- Herrin, Alejandro N. "An Assessment of Population, Health, and Education Policies in the Philippines, 1986-1988." *Working Paper Series No. 90-10*. Makati: Philippine Institute for Development Studies, 1990.
- _____. "Human Resource Foundation in the Philippines: Problems and Prospect" *NUPRI Research Paper Series No. 43*. Tokyo: Nihon University Population Research Institute, 1988.
- _____. "Economic Demographic Adjustment to Economic Stress: The Case of the Urban Poor." Paper presented in the 9th Annual Scientific Meeting of the National Academy of Science and Technology, Manila, 1987.
- _____. "Changing Economic Environment and the Welfare of Low Income Groups in the Philippines." *Transactions of the National Academy of Science and Technology* 3 (1986): 259-286.
- _____ and V. Paqueo. "Demographic Trends, Population Policy and the Economic Crisis." *Transactions of the National Academy of Science and Technology* 7 (1985): 335-357.
- _____. "Socioeconomic Demographic Impact: The Case of Rural Electrification." In *Perspective for Population and Development Planning*. Manila: Commission on Population and National Economic and Development Authority, 1984.
- Hicks, Norman and Anne Kubisch. "Cutting Government Expenditures in LDCs." *Finance and Development*. September, 1984.
- _____. "The Effect of Expenditures Reduction in Developing Countries." Mimeographed. Washington, D.C.: World Bank, 1984a.
- Iqbal, Farrukh. "Subsidies, Rationing and Access: The Case of Concessional Agricultural Credit." Mimeographed, 1989.
- Islam, Shafiqul. "Devaluation, Stabilization Policies and the Developing Countries: A Macroeconomic Analysis." *Journal of Development Economics* 14 (1984): 37-60.

- Jimenez, E.V. Paqueo and L. de Vera. "Student Performance and School Costs in the Philippines High School." *Policy Planning and Research Working Paper No. 61*, Washington D.C.: World Bank, 1988a.
- _____. "Does Local Financing Make Primary Schools More Efficient?" *Policy, Planning and Research Working Paper No. 69*, Washington D.C.: World Bank, 1988b.
- Johnson, D. Gale. "Agricultural Structural Policies." In *Growth-Oriented Adjustment Programs*, edited by Vittorio Corbo, *et al.* Washington D.C.: World Bank, 1987.
- Johnson, O. and J. Salop. "Distributional Aspects of Stabilization Programs in Developing Countries." *IMF Staff Papers No. 27*. International Monetary Fund, 1980
- Jolly, Richard. "A UNICEF Perspective on the Effects of Economic Crisis and What can be Done." In *Health, Nutrition and Economic Crises: Approaches to Policy in the Third World*, edited by David Bell and Michael Reich. Dover, Massachusetts: Auburn House Publishing Company, 1988.
- _____. and Cornia, Giovanni. *The Impact of World Recession on Children*. Oxford: Pergamon Press, 1984.
- Kanbur, S.M.R. "Measurement and Alleviation of Poverty." *IMF Staff Papers No. 34*. International Monetary Fund, 1987.
- _____. "Structural Adjustment, Macroeconomic Adjustment and Poverty: A Methodology for Analysis." *World Development* 15 (1987a): 1515-1526.
- Killick, T., ed. *The Quest for Economic Stabilization: The IMF and the Third World*. London: Heinemann, 1984.
- King, E. and L. Lilbud. "Determinants of Schooling Attainment and Enrolment Rates in the Philippines." Prepared for the U.S. Agency for International Development. California: The Road Corporation, 1983.
- Lamberte, Mario B. and Julius P. Relampagos. "An Assessment of Policies Affecting the Financial Sector, 1986-1988." *Working Paper Series No. 90-05*. Makati: Philippine Institute for Development Studies, 1990.
- Layo, L. "Morbidity and the Philippine Welfare in the Year 2000." *Population, resources, Environment and the Philippine Future: A Final Report*. (Paper Series No. 13). Vol. IV-1.A, 1977.
- Lecaillon, Morisson and Snyder Thorbecke. *Macroeconomic Policies and Agricultural Performance in Poor countries*. Paris: Organization for Economic Cooperation and Development, 1987.
- Lockheed, M., S. Vail, and b. Fuller. "Why Textbooks Affect Achievement in Developing Countries: Evidence from Thailand." *EDT Series No. 53*. Washington D.C.: Education and Training Department, 1987.
- Manasan, Rosario G. "An Assessment of Fiscal Policy in the Philippines, 1986-1988." *Working Paper Series No. 90-06*. Makati: Philippine Institute for Development Studies, 1990.
- Marin, A., *et al.* "Co-Variates of Child Mortality in the Philippines, Indonesia and Pakistan: An Analysis Based on Hazard Models." *Population Studies* 37 (1983): 417-432.
- McKinnon, Ronald I. *Money and Capital in Economic Development*, Washington D.C.: The Brookings Institution, 1973.

- Medalla, Erlinda M. "An Assessment of Trade and Industrial Policy, 1986-1988." *Working Paper Series No. 90-07*. Makati: Philippine Institute for Development Studies, 1990.
- Montes, Manuel F. "Review of Structural Adjustment in the Philippines." *Journal of Philippine Development* 15 (1988): 139-165.
- _____. "Macroeconomic Adjustment in the Philippines, 1983-1985." *Working Paper Series No. 87-01*. Makati: Philippine Institute for Development Studies, 1987.
- _____. "The 1983-85 Philippine Macroeconomic Adjustment: Some unresolved Issues." *V.R.F. Series No. 138*. Tokyo: Institute of Developing Studies, 1986.
- Nabli, M.K. and J.B. Nugent. "The New Institutional Economics and its Applicability to Development." *World Development* 17 (1989): 1333-1348.
- Nelson, Joan M., *et al.* "Fragile Coalitions: The Politics of Economic Adjustment." US-Third World Policy Perspective No. 12. New Brunswick, N.J.: Transaction Books, 1989.
- North, D.C. "Institutions and Economic Growth: A Historical Introduction." *World Development* 17 (1989): 1319-1332.
- Ona, M., R. Ellis, J. Huber, J. and O. Solon. "The Consequence of Adult Ill-Health." In *The Health of Adults in the Developing World* edited by R. Feachem, T. Kgelstrom, C. Munay, M. Ona and M. Philips. Prepared by Corporate Science, Inc. Atlanta for the Population and Human Resources Department of the World Bank, June 1990.
- Oshima, H. "Human Resources in East Asia's Secular Growth." *Economic Development and Cultural Change* 36 (1988): S103-S122.
- Paderanga, C. "Tertiary Education in the Philippines: Individual Rationality and Social Myopia." In *Studies in Economic Policy and Institutions: The Philippines, 1990*. Edited by Canlas and Sakai. Tokyo: Institute of Developing Economies, 1990.
- _____. "Socio-economic and Demographic Aspects of Education in the Philippines." Unpublished paper. Quezon City: Center for Integrative Development Studies, University of the Philippines, 1986.
- Pante, Fiologo, Jr. and Erlinda M. Medalla. "The Philippine Industrial Sector: Policies, Programs, and Performance." *Working Paper Series No. 90-18*. Makati: Philippine Institute for Development Studies, 1990.
- Paqueo, V. "An Econometric Analysis of Educational Attainment among Elementary School-Age Children: Preliminary Analysis." *Transactions of the National Academy of Science and Technology (Philippines)* 7 (1985): 359-380.
- _____. "Household Utilization of Health Care Services: A Quantitative Analysis." In Final Report: Population Resources, Environment and the Philippine Future. Unpublished report. School of Economics, University of the Philippines, Quezon City 1977.
- Pastor, M. "The Effects of IMF Programmes in the Third World: Debate and Evidence from Latin America." *World Development* (Forthcoming).
- Pfeffermann, Guyp. "Public Expenditure in Latin America: Effects on Poverty." *Discussion Paper N. 5*. Washington, D.C.: World Bank, 1987.

- Popkin, B. "Rural Women, Work, and Child Welfare in the Philippines." In *Women and Poverty in the Third World*, edited by M. Buvinic, et al. London: The John Hopkins University Press, 1980.
- Psacharopoulos, G. "Education and Development: A Review." *The World Bank Research Observer* 3 (1988): 99-116.
- Quisumbing, A. "Food Demand Parameters and their Application to Nutrition Policy Simulation." *The Philippine Review of Economics and Business* 22 (1985): 177-213.
- Ranis, Gustav. "Adjustment, Growth, and Debt Fatigue." *Occasional Paper No. 17*. U.S.A.: International Center for Economic Growth, 1989.
- Reyes, Edna A. Ma. Teresa C. Sanchez. "An Assessment of Labor and Employment in the Philippines, 1986-1988." *Working Paper Series No. 90-09*. Makati: Philippine Institute for Development Studies, 1990.
- Ribe, Helena and Soniya Carvalho. "Adjustment and the Poor." *Finance and Development* September 1990.
- Ribe, Helena, et al. "How Adjustment Programs can Help the Poor: The World Bank's Experience." *Discussion Paper No. 71*. Washington D.C.: World Bank, 1990.
- Samia, Patricia M, and Rhodora Concepcion, "Poverty and Living Wage Levels: A Survey of Recent Estimate." *CRC Staff Memos No. 7*. Pasig: Center for Research and Communication, 1989.
- _____. "Poverty and Living Wage Levels: A Survey of Recent Estimates." *CRC Staff Memos*, no. 25. Pasig, Metro Manila: Center for Research and Communication, 1989.
- Selowsky, M. and I. Taylor. "The Economics of Malnourished Children: An Example of Disinvestment in Human Capital," *Economic Development and Cultural Change* 22 (1973): 17-30.
- Shultz, "The Value of the Ability to Deal with Disequilibria." *Journal of Economic Literature* 13 (1975): 827-846.
- Singh, Squere and Kirchner. "Agricultural Pricing and Marketing Policies in an African Context: A Framework for Analysis," *Economic Development and Cultural Change* 22 (1973): 17-30.
- Smith, A. *The Wealth of Nations*. New York: Random House, 1937.
- Solon, Orville. "The Health Impact of Urban Poor Housing and Environmental Conditions." *Working Paper Series No. 89-14*. Makati: Philippine Institute for Development Studies, 1989.
- Soto, Hernando de. "Structural Adjustment and the Informal Sector." In *Microenterprises in Developing Countries*, edited by Jacob Levitsky. London: Intermediate Technology Publications, 1989.
- Stewart, Frances. "Monitoring and Statistics for Adjustment with a Human Face." In *Adjustment with a Human Face*, edited by Giovanni Andea Cornia, Richard Jolly, and Frances Stewart. Oxford: Oxford University Press, 1987.
- _____. "Alternative Macropolicies, Meso Policies, and Vulnerable Groups." In *adjustment with a Human Face*, edited by Giovanni Andea Cornia, Richard Jolly, and Frances Stewart. Oxford: Oxford University Press, 1987a.

- Taylor, Lance. *Structuralist Macroeconomics: Applicable Models for the Third World*. New York: Basic Books, Inc., 1983.
- Thorbecke, Erik. "The Impact of Stabilization and Structural Adjustment Measures and Reforms on Agriculture and Equity." In *Policy Reform and Equity: Extending the Benefits of Development*, edited by Elliot Berg. California: Sequoia Institute, 1998.
- Timmer, Peter. "Food Policy and Economic Adjustment." In *Health Nutrition on Economic Crisis: Approaches to Policy in the Third World*, edited by Bell and Reich. Massachusetts: Auburn House, 1988.
- UNICEF. "Redirecting Adjustment Programmes toward Growth and the Protection of the Poor: The Philippine Case." In *Adjustment with a Human Face*, edited by G. Cornia, R. Jolly, and F. Stewart. Oxford: Oxford University Press, 1988.
- Valenzuela, R. "Nutrient Distribution within the Family." *The Philippine Economic Journal* 17 (1978): 168-184.
- Van de Welle, Dominique. "Policies for Reducing Poverty." *Finance and Development*, (September 1990): 6-8.
- Walton, Michael. "Combating Poverty: Experience and Prospects." *Finance and Development*, (September 1990): 2-5.
- Waterbun, John. "The Political Management of Economic Adjustment and Reform." In *Fragile Conditions: The Politics of Economic Adjustment*, by Joan M. Nelson, et al. New Burnsmich, New Jersey: Transaction Books, 1985.
- Welch. "Education in Production." *Journal of Political Economy* 78 (1970): 35-39.
- Wolfe, B. and Jere R. Berhman. "Is Income Overstated in Determining Adequate Nutrition?" *Economic Development and Cultural Change* 31 (1983): 525-550.
- _____. "Determinants of Child Mortality, Health and Nutrition in a Developing Country." *Journal of Development Economics* volume 11 (1982): 163-194.
- World Bank. *The Philippines: The Challenges of Poverty*. Washington D.C.: The World Bank, 1988.
- Yap, Josef T. "An Assessment of the External Debt Management in the Philippines, 1986-1988." *Working Paper Series No. 90-04*. Makati: Philippine Institute for Development Studies, 1990a.
- _____. "The Philippines: Recent Performance, Prospects for 1990-1991, and Policy and Development Issues." *Working Paper Series No. 90-01*. Makati: Philippine Institute for Development Studies, 1990a
- Ybañez-Gonzalo S. and R. Evenson. "The Production and Consumption of Nutrients in Laguna Households: An Exploratory Analysis." *The Philippine Economic Journal* 17 (1978): 136-153.
- Zablan, Z. "Demographic and Health Perspective of the Status of Women and Children in the Philippines." Report prepared for UNICEF, 1986. Quezon City: University of the Philippines Population Institute.
- _____. "Philippine Trends in Breastfeeding Practice." Mimeographed, 1985.